



 **DANCELIGHT LED**

14th Edition

# Brand Value



- Diverse
- Quality
- Affordable

Jan Cheng Lighting Co., Ltd. established in 1987. We are Taiwan's leading lighting supplier. With 30 years of experience in lighting application and marketing, we created DanceLight in 2008. DanceLight is now Taiwan's leading LED lighting brand in terms of the market share.

We provide diverse, quality, and affordable LED lighting products to customers. Our LED lighting products can be used in commercial, residential, outdoor, and industrial applications. Which, in turn, covers over more than 300 items listed in this catalogue, includes retrofits, indoor and outdoor lights.

## A Total Solution For Lighting



Taiwan Head Office

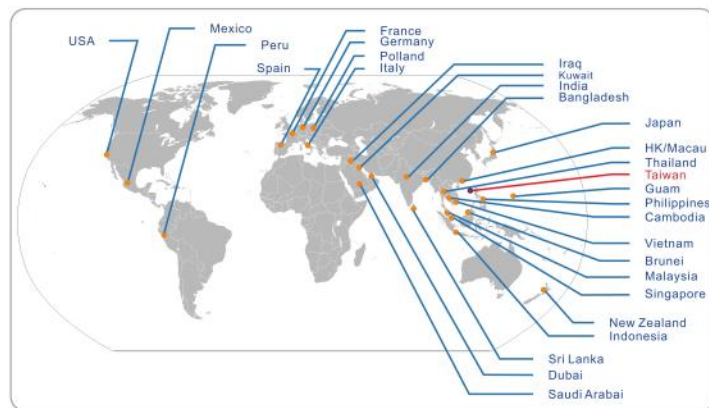

Sales Network

# CONTENTS

## INDOOR

LED Wall Light.....	01
LED Angle-Adjustable Downlight.....	06
LED High Ceiling Downlight.....	07
LED Spot/Downlight.....	10
LED AR111 / MR16 Ceiling Fixture.....	15
LED Ra90 Track Light.....	19
LED Dimmable Ceiling Light.....	20
LED Ceiling Mounted Light.....	22
LED High CRI MR16.....	27
LED High CRI AR111.....	28
LED Filament Light.....	29
LED Bulb.....	30
LED T8 Tube.....	32
LED T5 Batten.....	33
LED Panel Light.....	34
LED T8 Tube Fixtures.....	36

## OUTDOOR

LED Wall Light.....	40
LED Lawn Light.....	46
LED Garden Spotlight.....	47
LED Flood Light.....	49
LED Microwave Sensor Light.....	52
LED Microwave Sensor Ceiling Light.....	53
LED Street Light.....	54
LED High Bay Light.....	55
LED Underground Light.....	57
LED Step/Stair Light.....	58
LED Light Strip.....	59

## Product Analysis



Goniophotometer



Distribution Curve



# LED Indoor Wall Light

## Features

- Simple design suitable for different styles
- High colour rendering index ra80+
- High quality die-casting aluminum material is applied



## Specification

Model Name	LED-26002	LED-26001
Voltage Range	100-240V	100-240V
Driver	Internal	Internal
Power Consumption	7W	7W
Color Temperature	3000K	3000K
Luminous Flux	250LM	350LM
Color Rendering Index	≥ 80	≥ 80
Lifetime(hrs)	15000	15000
Body Material	Die-casting Aluminum, PMMA	Die-casting Aluminum, PMMA
Dimensions	H100mm*L100mm*D80mm	H100mm*L200mm*D80mm



# LED Indoor Wall Light

## Features

- Simple design suitable for different styles
- High colour rendering index ra80+
- High quality die-casting aluminum material is applied



LED-26002-BK



LED-26001-BK

## Specification

Model Name	LED-26002-BK	LED-26001-BK
Voltage Range	100-240V	100-240V
Driver	Internal	Internal
Power Consumption	7W	7W
Color Temperature	3000K	3000K
Luminous Flux	250LM	350LM
Color Rendering Index	≥ 80	≥ 80
Lifetime(hrs)	15000	15000
Body Material	Die-casting Aluminum, PMMA	Die-casting Aluminum, PMMA
Dimensions	H100mm*L100mm*D80mm	H100mm*L200mm*D80mm

# LED Indoor Wall Light

## Features

- Simple design suitable for different styles
- High colour rendering index ra80+
- High quality die-casting aluminum material is applied



## Specification

Model Name	LED-26005	LED-26008
Voltage Range	100-240V	100-240V
Driver	Internal	Internal
Power Consumption	7W	7W
Color Temperature	3000K	3000K
Luminous Flux	490LM	480LM
Color Rendering Index	≥ 80	≥ 80
Lifetime(hrs)	15000	15000
Body Material	Die-casting Aluminum, PMMA	Die-casting Aluminum, PMMA
Dimensions	H120mm*L230mm*D90mm	H140mm*L140mm*D66mm

# LED Indoor Wall Light

## Features

- Lighting angle is adjustable
- High colour rendering index ra80+
- High quality die-casting aluminum material is applied

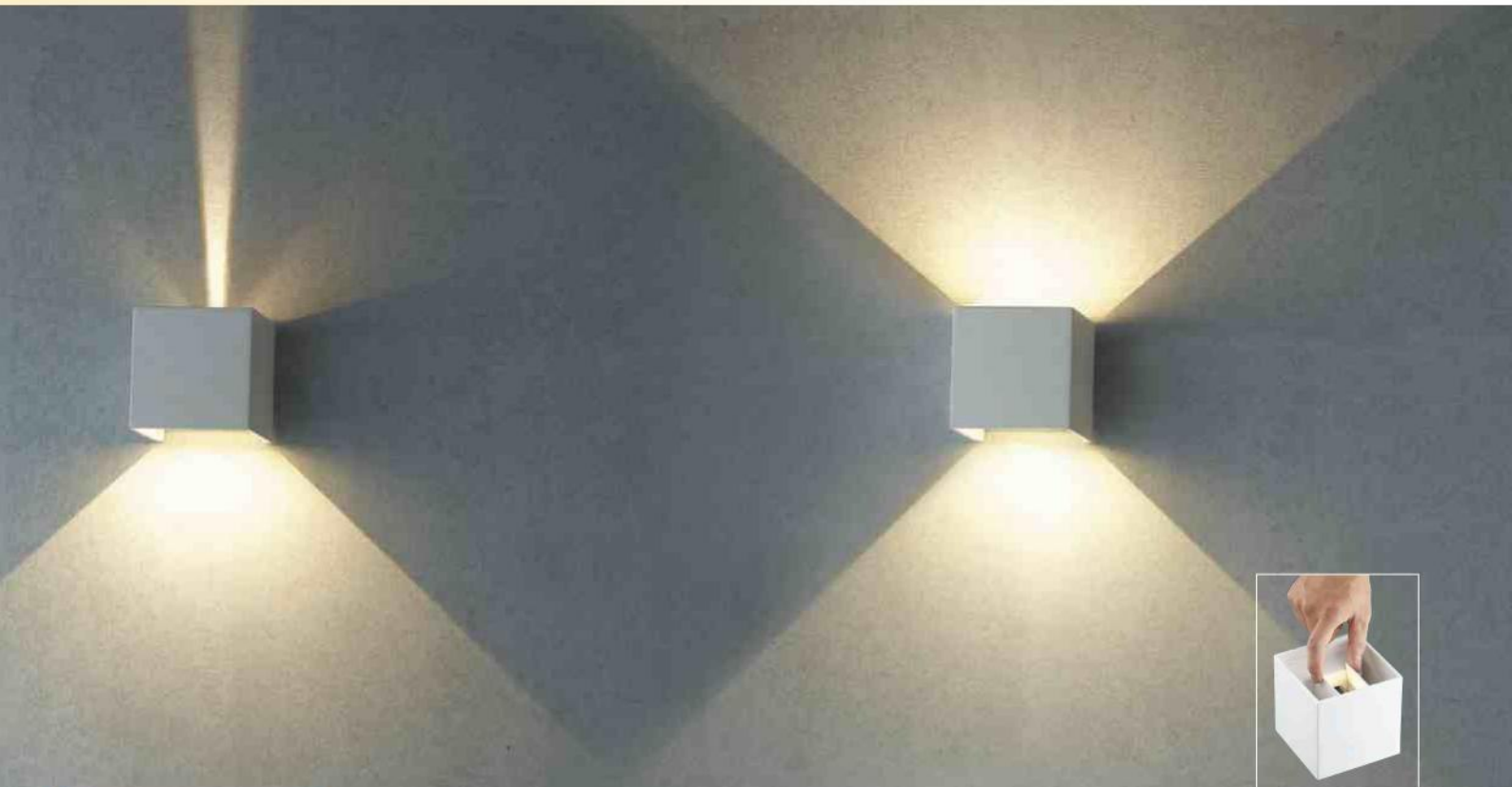

angle adjustable

## Specification

Model Name	LED-26007
Voltage Range	100-240V
Driver	Internal
Power Consumption	7W
Color Temperature	3000K
Luminous Flux	380LM
Color Rendering Index	≥ 80
Lifetime(hrs)	15000
Body Material	Die-casting Aluminum, Glass Diffuser
Dimensions	H100mm*L100mm*D100mm



# LED Indoor Wall Light

## Features

- Simple design suitable for different styles
- High colour rendering index ra80+
- High quality die-casting aluminum material is applied



## Specification

Model Name	LED-21033	OD-2277
Voltage Range	100-240V	100-240V
Driver	Internal	Internal (waterproof driver)
Power Consumption	<b>12W</b>	<b>8W</b>
Color Temperature	3000K	3000K
Luminous Flux	970LM	500LM
Color Rendering Index	≥ 80	≥ 80
Lifetime(hrs)	15000	15000
Body Material	Die-casting Aluminum, PMMA	Die-casting Aluminum, Glass
Dimensions	H108mm*L100mm*D100mm	H110mm*L110mm*D110mm



# LED High Ceiling Downlight

## Features

- PHILIPS lighting module applied (LED chip+ Driver)
- High colour rendering index ra80+
- Suitable for 6 - 8 meters high



PHILIPS LED COB Module

## Specification

<b>Model Name</b>	LED-25123D LED-25123N LED-25123W	LED-25126D LED-25126N LED-25126W	LED-25122D LED-25122N LED-25122W
<b>Voltage Range</b>	100-240V	100-240V	
<b>Driver</b>	External, included	External, included	
<b>Power Consumption</b>	<b>30W</b>	<b>45W</b>	
<b>Color Temperature</b>	5000K±10% (D) 4000K±10% (N) 3000K±10% (W)	5000K±10% (D) 4000K±10% (N) 3000K±10% (W)	
<b>Luminous Flux</b>	3100LM (D) 3000LM (N) 3000LM (W)	4400LM (D) 4250LM (N) 4250LM (W)	
<b>Color Rendering Index</b>	≥ 80	≥ 80	
<b>Lifetime(hrs)</b>	25000	25000	
<b>Field Angle</b>	100°	100°	
<b>Body Material</b>	Die-casting Aluminum	Die-casting Aluminum	
<b>Dimensions</b>	Φ170mm*H95mm	Φ190mm*H100mm	Φ225mm*H115mm
<b>Installation Size</b>	Φ155mm	Φ175mm	Φ205mm





# LED High Ceiling Downlight

## Features

- PHILIPS lighting module applied (LED chip+ Driver)
- High colour rendering index ra80+
- Suitable for 6 - 8 meters high



  $\Phi 210\text{mm}$   
  $\Phi 240\text{mm}$

## Specification

<b>Model Name</b>	LED-21"DOD30D LED-21"DOD30N LED-21"DOD30W	LED-24"DOD30D LED-24"DOD30N LED-24"DOD30W	LED-21"DOD45D LED-21"DOD45N LED-21"DOD45W	LED-24"DOD45D LED-24"DOD45N LED-24"DOD45W
<b>Voltage Range</b>	100-240V	100-240V	100-240V	100-240V
<b>Driver</b>	External, included	External, included	External, included	External, included
<b>Power Consumption</b>	<b>30W</b>	<b>30W</b>	<b>45W</b>	<b>45W</b>
<b>Color Temperature</b>	5000K $\pm$ 10% (D) 4000K $\pm$ 10% (N) 3000K $\pm$ 10% (W)		5000K $\pm$ 10% (D) 4000K $\pm$ 10% (N) 3000K $\pm$ 10% (W)	
<b>Luminous Flux</b>	2700LM (D) 2350LM (N) 2350LM (W)		4300LM (D) 3700LM (N) 3700LM (W)	
<b>Color Rendering Index</b>	$\geq 80$ (D) $\geq 90$ (N)(W)		$\geq 80$ (D) $\geq 90$ (N)(W)	
<b>Lifetime(hrs)</b>	25000	25000	25000	25000
<b>Beam Angle</b>	50°	50°	50°	50°
<b>Body Material</b>	Die-casting Aluminum	Die-casting Aluminum	Die-casting Aluminum	Die-casting Aluminum
<b>Dimensions</b>	$\Phi 220\text{mm} \times \text{H}141\text{mm}$	$\Phi 260\text{mm} \times \text{H}143\text{mm}$	$\Phi 220\text{mm} \times \text{H}141\text{mm}$	$\Phi 260\text{mm} \times \text{H}143\text{mm}$
<b>Installation Size</b>	$\Phi 210\text{mm}$	$\Phi 240\text{mm}$	$\Phi 210\text{mm}$	$\Phi 240\text{mm}$

# LED High Ceiling Downlight

## Features

- CREE LED chip and MeanWell Driver are applied
- High colour rendering index ra80+
- Suitable for 3-4 meters high

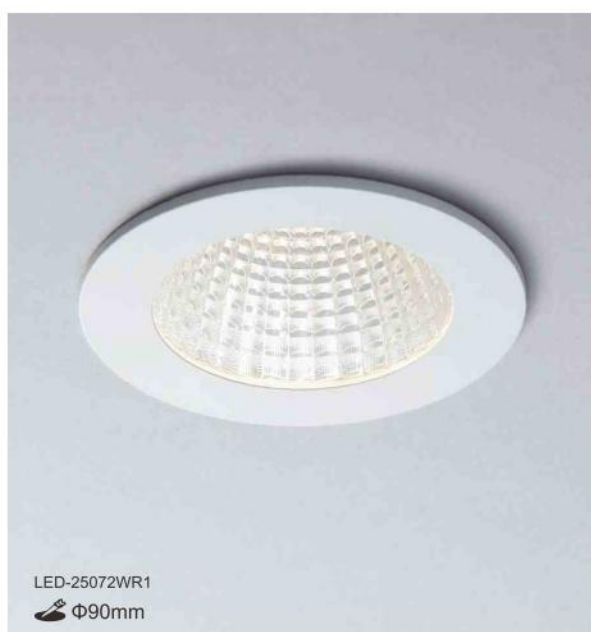

## Specification

<b>Model Name</b>	LED-25072DR1 LED-25072NR1 LED-25072WR1	LED-25074DR1 LED-25074NR1 LED-25074WR1
<b>Voltage Range</b>	100-240V	100-240V
<b>Driver</b>	External, included	External, included
<b>Power Consumption</b>	<b>12W</b>	<b>24W</b>
<b>Color Temperature</b>	6000K±10% (D) 4000K±10% (N) 3000K±10% (W)	6000K±10% (D) 4000K±10% (N) 3000K±10% (W)
<b>Luminous Flux</b>	700LM (D) 580LM (N) 580LM (W)	1350LM (D) 1100LM (N) 1100LM (W)
<b>Color Rendering Index</b>	≥ 80(D)(W) ≥ 90(N)	≥ 80(D)(W) ≥ 90(N)
<b>Lifetime(hrs)</b>	25000	25000
<b>Beam Angle</b>	45°	45°
<b>Body Material</b>	Die-casting Aluminum, Glass Cover	Die-casting Aluminum, Glass Cover
<b>Dimensions</b>	Φ105mm*H70mm	Φ170mm*H90mm
<b>Installation Size</b>	Φ90mm	Φ155mm

# LED Spot/Downlight

## Features

- CREE LED chip and MeanWell Driver are applied
- High colour rendering index ra80+
- Suitable for 6 meters high



## Specification

<b>Model Name</b>	LED-25076DR1 LED-25076NR1 LED-25076WR1	LED-25132D LED-25132N LED-25132W	LED-25101D LED-25101N LED-25101
<b>Voltage Range</b>	100-240V	100-240V	100-240V
<b>Driver</b>	External, included	External, included	External, included
<b>Power Consumption</b>	<b>9W</b>	<b>12W</b>	<b>12W</b>
<b>Color Temperature</b>	6000K±10% (D) 4000K±10% (N) 3000K±10% (W)	6000K±10% (D) 4000K±10% (N) 3000K±10% (W)	6500K±10% (D) 4000K±10% (N) 3000K±10% (W)
<b>Luminous Flux</b>	450LM (D) 400LM (N) 400LM (W)	900LM (D) 700LM (N) 700LM (W)	600LM (D) 500LM (N) 500LM (W)
<b>Color Rendering Index</b>	≥ 80(D) ≥ 90(N)(W)	≥ 80(D) ≥ 90(N)(W)	≥ 80(D) ≥ 90(N)(W)
<b>Lifetime(hrs)</b>	25000	25000	25000
<b>Beam Angle</b>	30°	35°	25°
<b>Body Material</b>	Die-casting Aluminum, Glass Cover	Die-casting Aluminum, Glass Cover	Die-casting Aluminum, Glass Cover
<b>Dimensions</b>	Φ82mm*H50mm	Φ103mm*H65mm	Φ110mm*H78mm
<b>Installation Size</b>	Φ70mm	Φ90mm	Φ90mm



# LED Spot/Downlight

## Features

- High colour rendering index ra80+
- High light transmittance and well-distributed lighting
- Suitable for projection lighting, creating nice atmosphere



## Specification

<b>Model Name</b>	LED-25097DR1 LED-25097NR1 LED-25097WR1(-BK)	LED-25090DR2 LED-25090NR2 LED-25090WR2(-BK)
<b>Voltage Range</b>	100-240V	100-240V
<b>Driver</b>	External, included	External, included
<b>Power Consumption</b>	<b>5W</b>	<b>8W</b>
<b>Color Temperature</b>	6000K±10% (D) 4000K±10% (N) 3000K±10% (W)	6000K±10% (D) 4000K±10% (N) 3000K±10% (W)
<b>Luminous Flux</b>	415LM (D) 385LM (N) 385LM (W)	750LM (D) 715LM (N) 715LM (W)
<b>Color Rendering Index</b>	≥ 80	≥ 80
<b>Lifetime(hrs)</b>	15000	15000
<b>Beam Angle</b>	18°	18°
<b>Body Material</b>	Aluminum, PC Diffuser	Aluminum, PC Diffuser
<b>Dimensions</b>	Φ85mm*H31mm	Φ107mm*H38mm
<b>Installation Size</b>	Φ70mm	Φ90mm

# LED Downlight

## Features

- High colour rendering index ra80+
- High light transmittance and well-distributed lighting
- Suitable for projection lighting, creating nice atmosphere



LED-15\"DOP16D  
LED-15\"DOP12D  
LED-12\"DOP12D



LED-15\"DOH16D



## Specification

Model Name	LED-15\"DOP16D LED-15\"DOP16N LED-15\"DOP16W	LED-15\"DOP12D LED-15\"DOP12N LED-15\"DOP12W	LED-12\"DOP12D LED-12\"DOP12N LED-12\"DOP12W	LED-15\"DOH16D LED-15\"DOH16W
Voltage Range	100-240V	100-240V	100-240V	100-240V
Driver	External, included	External, included	External, included	External, included
Power Consumption	<b>16W</b>	<b>12W</b>	<b>12W</b>	<b>16W</b>
Color Temperature	6000K±10% (D) 4000K±10% (N) 3000K±10% (W)	6000K±10% (D) 4000K±10% (N) 3000K±10% (W)	6000K±10% (D) 4000K±10% (N) 3000K±10% (W)	6000K±10% (D) 3000K±10% (W)
Luminous Flux	1320LM (D) 1300LM (N) 1210LM (W)	935LM (D) 920LM (N) 920LM (W)	935LM (D) 920LM (N) 920LM (W)	1300LM (D) 1175LM (W)
Color Rendering Index	≥ 80	≥ 80	≥ 80	≥ 80
Lifetime(hrs)	15000	15000	15000	15000
Field Angle	160°	160°	160°	160°
Body Material	Aluminum, PC Diffuser	Aluminum, PC Diffuser	Aluminum, PC Diffuser	Aluminum, Glass Diffuser
Dimensions	Φ175mm*H31mm	Φ175mm*H31mm	Φ138mm*H31mm	Φ180mm*H43mm
Installation Size	Φ150mm	Φ150mm	Φ120mm	Φ150mm

# LED Ultra-thin Downlight

## Features

- High colour rendering index ra80+
- Ultra-thin lamp body design, saving installation space
- Suitable for living room, bedroom, indirect lighting



## Specification

Model Name	LED-25081R1 LED-25082R1	LED-25065-W
Voltage Range	100-240V	100-240V
Driver	External, included	External, included
Power Consumption	<b>12W</b>	<b>1W</b>
Color Temperature	5700K $\pm$ 10% (D) 3000K $\pm$ 10% (W)	3000K $\pm$ 10% (W)
Luminous Flux	1040LM (D) 990LM (W)	60LM
Color Rendering Index	$\geq 80$	$\geq 80$
Lifetime(hrs)	20000	15000
Field Angle	160°	30°
Body Material	Aluminum, PC Diffuser	Aluminum, PC Diffuser
Dimensions	$\Phi 176\text{mm} \times \text{H}23\text{mm}$	$\Phi 64\text{mm} \times \text{H}16\text{mm}$
Installation Size	$\Phi 155\text{mm}$	$\Phi 60\text{mm}$



# LED Spotlight/Downlight

## Features

- High colour rendering index ra80+
- Ultra-thin lamp body design, saving installation space
- Suitable for department store, retail shop, any commercial application



LED-25129D  
LED-25128D



LED-25130D  
LED-25131D

## Specification

Model Name	LED-25129D LED-25129N LED-25129W	LED-25128D LED-25128N LED-25128W	LED-25130D LED-25130N LED-25130W	LED-25131D LED-25131N LED-25131W
<b>Voltage Range</b>	100-240V	100-240V	100-240V	100-240V
<b>Driver</b>	External, included	External, included	External, included	External, included
<b>Power Consumption</b>	<b>12W</b>	<b>24W</b>	<b>24W</b>	<b>48W</b>
<b>Color Temperature</b>	6000K±10% (D) 4000K±10% (N) 3000K±10% (W)	6000K±10% (D) 4000K±10% (N) 3000K±10% (W)	6000K±10% (D) 4000K±10% (N) 3000K±10% (W)	6000K±10% (D) 4000K±10% (N) 3000K±10% (W)
<b>Luminous Flux</b>	760LM (D) 700LM (N) 700LM (W)	1560LM (D) 1200LM (N) 1200LM (W)	1700LM (D) 1400LM (N) 1400LM (W)	3100LM (D) 2800LM (N) 2800LM (W)
<b>Color Rendering Index</b>	≥ 80(D) ≥ 90(N)(W)	≥ 80(D) ≥ 90(N)(W)	≥ 80(D) ≥ 90(N)(W)	≥ 80(D) ≥ 90(N)(W)
<b>Lifetime(hrs)</b>	25000	25000	25000	25000
<b>Beam Angle</b>	45°	45°	45°	45°
<b>Body Material</b>	Die-casting Aluminum	Die-casting Aluminum	Die-casting Aluminum	Die-casting Aluminum
<b>Dimensions</b>	□138mm*H115mm	□138mm*H115mm	W260mm*D138*H115mm	W260mm*D138*H115mm
<b>Installation Size</b>	□125mm	□125mm	248*125mm	248*125mm

# LED AR111 Ceiling Fixture

## Features

- Simple design suitable for different styles
- Suitable for living room, shops, commercial applications



DL-31015W-WR



DL-31018W-WR



DL-31019W-WR



DL-31017W-WR



DL-31018-BK



DL-31018-BK

## Specification

<b>Model Name</b>	DL-31015W-WR	DL-31017W-WR	DL-31018-BK DL-31018W-WR	DL-31018-BK DL-31019W-WR
<b>Retrofit</b> (not included)	LED AR111 * 4 pcs	LED AR111 * 3 pcs	LED AR111 * 2 pcs	LED AR111 * 1 pcs
<b>Body Material</b>	Iron	Iron	Iron	Iron
<b>Dimensions</b>	□375*H80mm	W195*L495*H80mm	W195*L345*H80mm	□195*H80mm
<b>Installation Size</b>	□335mm	W160*L460mm	W160*L310mm	□160mm

# LED AR111 / MR16 Ceiling Fixture

## Features

- Simple design suitable for different styles
- Suitable for living room, shops, commercial applications



LED-25062-WR



LED-25064-WR



LED-25063-WR



LED-25064-MR16



LED-25063-MR16

## Specification

Model Name	LED-25062-WR	LED-25063-WR	LED-25064-WR	LED-25063-MR16	LED-25064-MR16
Retrofit (not included)	LED AR111 * 3 pcs	LED AR111 * 2 pcs	LED AR111 * 1 pc	LED MR16 * 2 pcs	LED MR16 * 1 pc
Body Material	Iron	Iron	Iron	Iron	Iron
Dimensions	W160*L460*H90mm	W160*L310*H90mm	□161*H90mm	W98*L190*H85mm	□98*H85mm
Installation Size	W161*L461mm	W161*L311mm	□161mm	W98*L190mm	□98mm



# LED AR111 / MR16 Ceiling Fixture

## Features

- Simple design suitable for different styles
- Suitable for living room, shops, commercial applications



  $\Phi 70\text{mm}$

DL-41018



  $\Phi 90\text{mm}$

DL-41035-B



  $\Phi 70\text{mm}$

DL-41018B



  $\Phi 75\text{mm}$

LED-25078R1



  $\Phi 150\text{mm}$

DL-31022

## Specification

Model Name	DL-41018B	DL-41018	LED-25078R1	DL-41035-B	DL-31022
Retrofit (not included)	LED MR16 * 1 pc	LED MR16 * 1 pc	LED MR16 * 1 pc	LED MR16 * 1 pc	LED AR111 * 1 pc
Body Material	Iron	Iron	Aluminum	Iron	Iron
Dimensions	$\Phi 80 \times H 45\text{mm}$	$\Phi 80 \times H 45\text{mm}$	$\Phi 80 \times H 45\text{mm}$	$\Phi 106 \times H 50\text{mm}$	$\Phi 176 \times H 70\text{mm}$
Installation Size	$\Phi 70\text{mm}$	$\Phi 70\text{mm}$	$\Phi 75\text{mm}$	$\Phi 90\text{mm}$	$\Phi 150\text{mm}$

# LED MR16/AR111 Tracklight Fixture

## Features

- Simple design suitable for different styles
- Suitable for living room, shops, commercial applications



LED-24001



LED-24002



LED-24001C



LED-24002C



LED-24006

## Specification

Model Name	LED-24001	LED-24002	LED-24001C	LED-24002C	LED-24006
Retrofit (included)	LED MR16 * 1 pc	LED MR16 * 1 pc	LED MR16 * 1 pc	LED MR16 * 1 pc	LED MR16 * 1 pc
Body Material	Iron	Iron	Iron	Iron	Iron
Dimensions	W120*H120*D72mm	W120*H120*D72mm	Φ104*H137mm	Φ104*H137mm	W120*H405*D72mm
Installation Size	two-wire track	two-wire track	Φ104mm	Φ104mm	two-wire track



LED-24010



LED-24010C



LED-24011



LED-24011C

## Specification

Model Name	LED-24010	LED-24010C	LED-24011	LED-24011C
Retrofit (included)	LED AR111 * 1 pc	LED AR111 * 1 pc	LED AR111 * 1 pc	LED AR111 * 1 pc
Body Material	Iron	Iron	Iron	Iron
Dimensions	W120*H210*D72mm	Φ95*H197mm	W120*H210*D72mm	Φ95*H197mm
Installation Size	two-wire track	Φ95mm	two-wire track	Φ95mm





# DANCELIGHT

## DIMMABLE LED CEILING LIGHT



Starry cover design

30w

50w



2.4GHz. RF  
Controller

-  Remote control ranges for 20 meters (max.)
-  One remote control can be paired with four lamps
-  Light brightness and colour temperature are dimmable

### Safety tests

EMC Pssed  
Electric Shock Test  
Insulation Test  
Heat Resistance Test  
Fixture Endurance Test

6500K

3000K



# LED Dimmable Ceiling Light

Starry Series

## Features

- Remote control ranges for 20 meters (max.)
- One remote control can be paired with four lamps
- Suitable for bedrooms, living rooms



30w

50w



Remote control interface

## Specification

	LED-CES30DM	LED-CES50DM
Model Name	LED-CES30DM	LED-CES50DM
Voltage Range	100-240V	100-240V
Driver	Included	Included
Power Consumption	<b>30W</b>	<b>50W</b>
Color Temperature	3000~6500K	3000~6500K
Luminous Flux	2900LM (4000K MAX)	5200LM (4000K MAX)
Color Rendering Index	≥ 80	≥ 80
Lifetime(hrs)	15000	15000
Field Angle	160°	160°
Body Material	Iron, PC diffuser	Iron, PC diffuser
Dimensions	Φ390mm*120mm	Φ555mm*135mm

# LED Ceiling Mounted Light

**Starry Series** (Non-Dimmable)

## Features

- Electric shock resistance design
- High colour rendering index ra80+
- Suitable for bedrooms, living rooms

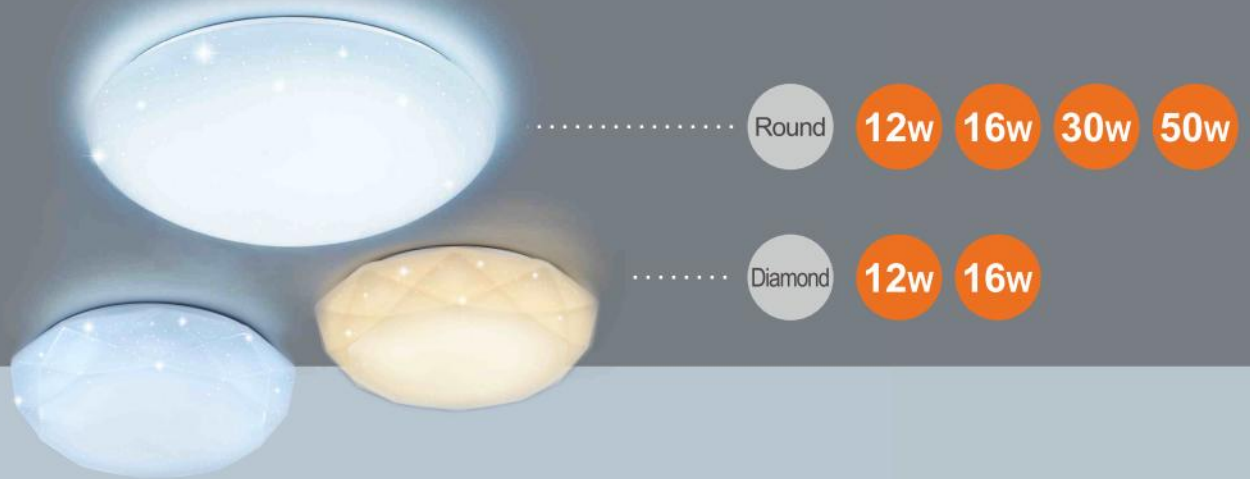

## Specification

Model Name	LED-CES12DR1 LED-CES12WR1	LED-CES16DR1 LED-CES16WR1	LED-CES30DR1 LED-CES30WR1	LED-CES50DR1 LED-CES50WR1	LED-CED12DR1 LED-CED12WR1	LED-CED16DR1 LED-CED16WR1
<b>Voltage Range</b>	100-240V	100-240V	100-240V	100-240V	100-240V	100-240V
<b>Driver</b>	Internal	Internal	Internal	Internal	Internal	Internal
<b>Power Consumption</b>	<b>12W</b>	<b>16W</b>	<b>30W</b>	<b>50W</b>	<b>12W</b>	<b>16W</b>
<b>Color Temperature</b>	6500K (D) 3000K (W)	6500K (D) 3000K (W)	6500K (D) 3000K (W)	6500K (D) 3000K (W)	6500K (D) 3000K (W)	6500K (D) 3000K (W)
<b>Luminous Flux</b>	900LM (D) 805LM (W)	1235LM (D) 1140LM (W)	2800LM (D) 2700LM (W)	4750LM (D) 4500LM (W)	900LM (D) 800LM (W)	1200LM (D) 1100LM (W)
<b>Color Rendering Index</b>	≥ 80	≥ 80	≥ 80	≥ 80	≥ 80	≥ 80
<b>Lifetime(hrs)</b>	15000	15000	15000	15000	15000	15000
<b>Field Angle</b>	160°	160°	160°	160°	160°	160°
<b>Body Material</b>	Iron, PC diffuser	Iron, PC diffuser	Iron, PC diffuser	Iron, PC diffuser	Iron, PC diffuser	Iron, PC diffuser
<b>Dimensions</b>	Φ265mm*90mm	Φ340mm*110mm	Φ390mm*120mm	Φ555mm*135mm	Φ265mm*81mm	Φ360mm*94mm



# LED Ceiling Mounted Light

(Non-Dimmable)

## Features

- Electric shock resistance design
- High colour rendering index ra80+
- Suitable for bedrooms, living rooms



12w

16w

30w

50w

## Specification

Model Name	LED-CE12DR1 LED-CE12WR1	LED-CE16DR1 LED-CE16WR1	LED-CE30DR1 LED-CE30WR1	LED-CE50DR1 LED-CE50WR1
Voltage Range	100-240V	100-240V	100-240V	100-240V
Driver	Internal	Internal	Internal	Internal
Power Consumption	12W	16W	30W	50W
Color Temperature	6500K (D) 3000K (W)	6500K (D) 3000K (W)	6500K (D) 3000K (W)	6500K (D) 3000K (W)
Luminous Flux	950LM (D) 850LM (W)	1300LM (D) 1200LM (W)	2900LM (D) 2800LM (W)	4900LM (D) 4700LM (W)
Color Rendering Index	≥ 80	≥ 80	≥ 80	≥ 80
Lifetime(hrs)	15000	15000	15000	15000
Field Angle	160°	160°	160°	160°
Body Material	Iron, PC diffuser	Iron, PC diffuser	Iron, PC diffuser	Iron, PC diffuser
Dimensions	Φ265mm*90mm	Φ340mm*110mm	Φ390mm*120mm	Φ555mm*135mm

# LED Cream White Glass Ceiling Light

with LED 12W Magnetic Module

## Features

- Cream white glass lamp cover
- High colour rendering index ra80+
- Suitable for bedrooms, staircase



LED 12W Magnetic Module

## Specification

Model Name	LED-21001-1 (wood texture)	LED-21002-1 (silver)	LED-21003-1 (white)	LED-2835*56D LED-2835*56W (module)
Voltage Range		--		100-240V
Driver		--		Included
Power Consumption		--		<b>12W</b>
Color Temperature		--		6500K (D) 3000K (W)
Luminous Flux		--		1050LM (D) 1000LM (W)
Color Rendering Index		--		≥ 80
Lifetime(hrs)		--		15000
Field Angle		--		180°
Body Material		Iron, Glass diffuser		Iron, PC diffuser
Dimensions		Φ230mm*80mm		Φ175mm*35.5mm

# LED Surface-Mounted Light

## Features

- Well-distributed light diffuser
- High colour rendering index ra80+
- Suitable for bedrooms, living rooms, staircase



LED-21029D



LED-21028D

## Specification

Model Name	LED-21028D LED-21028W	LED-21029D LED-21028W
Voltage Range	100-240V	100-240V
Driver	Included	Included
Power Consumption	<b>12W</b>	<b>18W</b>
Color Temperature	6000K (D) 3000K (W)	6000K (D) 3000K (W)
Luminous Flux	1040LM (D) 990LM (W)	1600LM (D) 1540LM (W)
Color Rendering Index	≥ 80	≥ 80
Lifetime(hrs)	15000	15000
Field Angle	160°	160°
Body Material	Aluminum, PC diffuser	Aluminum, PC diffuser
Dimensions	Φ170mm*35mm	Φ220mm*37mm



# LED Surface-Mounted Downlight

## Features

- Black housing is available
- High colour rendering index ra80+
- Suitable for concourse, reception, staircase



LED-CED12D  
LED-CED24D



LED-CED30D  
LED-CED45D

## Specification

Model Name	LED-CED12D LED-CED12N LED-CED12W	LED-CED24D LED-CED24N LED-CED24W	LED-CED30D LED-CED30N LED-CED30W	LED-CED45D LED-CED45N LED-CED45W
<b>Voltage Range</b>	100-240V	100-240V	100-240V	100-240V
<b>Driver</b>	Included	Included	Included	Included
<b>Power Consumption</b>	<b>12W</b>	<b>24W</b>	<b>30W</b>	<b>45W</b>
<b>Color Temperature</b>	6000K±10% (D) 4000K±10% (N) 3000K±10% (W)	6000K±10% (D) 4000K±10% (N) 3000K±10% (W)	5000K±10% (D) 4000K±10% (N) 3000K±10% (W)	5000K±10% (D) 4000K±10% (N) 3000K±10% (W)
<b>Luminous Flux</b>	800LM (D) 650LM (N) 650LM (W)	1400LM (D) 1300LM (N) 1300LM (W)	2500LM (D) 2100LM (N) 2100LM (W)	2800LM (D) 2500LM (N) 2500LM (W)
<b>Color Rendering Index</b>	≥ 80(D)(N) ≥ 90(W)	≥ 80(D)(N) ≥ 90(W)	≥ 80(D)(N) ≥ 90(W)	≥ 80(D)(N) ≥ 90(W)
<b>Lifetime(hrs)</b>	25000	25000	25000	25000
<b>Beam Angle</b>	40°	40°	40°	40°
<b>Body Material</b>	Die-casting Aluminum	Die-casting Aluminum	Die-casting Aluminum	Die-casting Aluminum
<b>Dimensions</b>	Φ120mm*H100mm	Φ120mm*H100mm	Φ170mm*H170mm	Φ190mm*H180mm

# LED High CRI MR16

## Features

- High colour rendering index ra80+
- No UV hazard, less heat produced within light
- Suitable for projection lighting, creating nice atmosphere



## Specification

Model Name	LED-MR166DR3 LED-MR166WR3	LED-MR168WR2	BF-LED8WA-JA
Voltage Range	12V DC	12V DC	Input:100-240V
Driver	External	External	Output: 12V DC / 700mA (max)
Power Consumption	<b>6W</b>	<b>8W</b>	—
Color Temperature	6000K±10% (D) 3000K±10% (W)	3000K±10% (W)	—
Luminous Flux	400LM	550LM	—
Color Rendering Index	≥ 80	≥ 80	—
Lifetime(hrs)	15000	15000	—
Beam Angle	36°	36°	—
Body Material	Thermally Conductive Plastics PC Diffuser	Thermally Conductive Plastics PC Diffuser	—
Dimensions	Φ50mm*45mm	Φ50mm*48mm	66mm*31mm*24mm

# LED High CRI AR111

## Features

- High colour rendering index ra80+
- No UV hazard, less heat produced with light
- Suitable for projection lighting, creating nice atmosphere



LED-AR9DR1



LED-AR14D

## Specification

<b>Model Name</b>	LED-AR9DR1 LED-AR9NR1 LED-AR9WR1	LED-AR14D LED-AR14N LED-AR14W
<b>Voltage Range</b>	100-240V	100-240V
<b>Driver</b>	External, included	External, included
<b>Power Consumption</b>	<b>9W</b>	<b>14W</b>
<b>Color Temperature</b>	5700K±10% (D) 4000K±10% (N) 2700K±10% (W)	5700K±10% (D) 4000K±10% (N) 2700K±10% (W)
<b>Luminous Flux</b>	880LM (D) 880LM (N) 800LM (W)	1250LM (D) 1150LM (N) 1150LM (W)
<b>Color Rendering Index</b>	≥ 80	≥ 80
<b>Lifetime(hrs)</b>	15000	15000
<b>Beam Angle</b>	24°	24°
<b>Body Material</b>	Die-casting Aluminum PC Diffuser	Die-casting Aluminum PC Diffuser
<b>Dimensions</b>	Φ111mm*20mm	Φ111mm*30mm



# LED Filament Light

## Features

- 6w filament can replace traditional 60w incandescent light
- Low lighting decay, high lighting efficiency
- Suitable for chandelier, vintage lighting fixture, or art-related spaces



## Specification

Model Name	LED-E27ED6C	LED-E27ED6YST64	LED-E27ED6CG125	LED-E27ED6C95	LED-E14ED4WC/TA	LED-E14ED4WC
Voltage Range	100-240V	100-240V	100-240V	100-240V	100-240V	100-240V
Driver	Internal	Internal	Internal	Internal	Internal	Internal
Power Consumption	6W	6W	6W	6W	4W	4W
Color Temperature	2700K±10%	2200K±10%	2700K±10%	2700K±10%	2700K±10%	2700K±10%
Luminous Flux	760LM	600LM	800LM	800LM	470LM	470LM
Color Rendering Index	≥ 80	≥ 80	≥ 80	≥ 80	≥ 80	≥ 80
Lifetime(hrs)	15000	15000	15000	15000	15000	15000
Field Angle	320°	320°	320°	320°	320°	320°
Body Material	Glass	Glass	Glass	Glass	Glass	Glass
Dimensions	Φ60mm*104mm	Φ63mm*138mm	Φ125mm*173mm	Φ94mm*138mm	Φ36mm*146mm	Φ36mm*116mm

# LED E27 Bulb

## Features

- Wide-angle lighting and high lumen output
- Suitable for general lighting, home use

### CFL Replacement

DanceLight LED Bulb	Brightness	CFL
3W (Night Light)	260 Lumen	8W
7W (Cabinet/Wall Light)	600 Lumen	13W
10W (Bedroom)	950 Lumen	23W
12W (Living Room)	1200 Lumen	27W
16W (Living Room)	1650 Lumen	32W



LED-E2716DR5



LED-E2712DR5



LED-E2710DR5



LED-E277DR2



LED-E273DR1

## Specification

Model Name	LED-E2716DR5 LED-E2716WR5	LED-E2712DR5 LED-E2712NR5 LED-E2712WR5	LED-E2710DR5 LED-E2710WR5	LED-E277DR2 LED-E277WR2	LED-E273DR1 LED-E273WR1
Voltage Range	100-240V	100-240V	100-240V	100-240V	100-240V
Driver	Internal	Internal	Internal	Internal	Internal
Power Consumption	<b>16W</b>	<b>12W</b>	<b>10W</b>	<b>7W</b>	<b>3W</b>
Color Temperature	6500K±10% (D) 3000K±10% (W)	6500K±10% (D) <b>4000K±10% (N)</b> 3000K±10% (W)	6500K±10% (D) 3000K±10% (W)	6500K±10% (D) 3000K±10% (W)	6500K±10% (D) 3000K±10% (W)
Luminous Flux	1650LM (D) 1550LM (W)	1200LM (D) 1200LM (N) 1150LM (W)	950LM (D) 900LM (W)	600LM (D) 570LM (W)	260LM (D) 230LM (W)
Color Rendering Index	≥ 80	≥ 80	≥ 80	≥ 80	≥ 80
Lifetime(hrs)	15000	15000	15000	15000	15000
Field Angle	320°	330°	330°	340°	320°
Body Material	Thermally Conductive Plastics PC Diffuser	Thermally Conductive Plastics PC Diffuser	Thermally Conductive Plastics PC Diffuser	Thermally Conductive Plastics PC Diffuser	Thermally Conductive Plastics PC Diffuser
Dimensions	Φ70mm*130mm	Φ60mm*114mm	Φ60mm*114mm	Φ60mm*113mm	Φ45mm*91mm

# LED High Brightness Bulb

## Features

- Wide-angle lighting and high lumen output
- Suitable for general lighting

### Replacement

DanceLight LED Bulb	Brightness	Traditional
14 W (Outdoor Spotlight)	1050 Lumen	PAR38 120 W
25 W (High Ceiling)	2500 Lumen	CFL 50 W
38 W (High Ceiling)	3800 Lumen	CFL 75 W
50 W (Industrial Light)	4800 Lumen	Mercury 250 W



LED-PAR3814W  
E27



LED-E2738D  
E27



LED-E4050D  
E40



LED-E2725D  
E27



## Specification

Model Name	LED-PAR3814W	LED-E2738D LED-E2738W	LED-E4050D	LED-E2725D LED-E2725W
Voltage Range	100-240V	100-240V	100-240V	100-240V
Driver	Internal	Internal	Internal	Internal
Power Consumption	14W	38W	50W	25W
Color Temperature	3000K±10%	6500K±10% (D) 3000K±10% (W)	6500K±10% (D)	6500K±10% (D) 3000K±10% (W)
Luminous Flux	1050LM	3800LM (D) 3520LM (W)	4800LM	2500LM (D) 2400LM (W)
Color Rendering Index	≥ 80	≥ 80	≥ 80	≥ 80
Lifetime(hrs)	15000	15000	15000	15000
Field Angle	33° (Beam Angle)	260°	300°	330°
Body Material	Thermally Conductive Plastics PC Diffuser	Thermally Conductive Plastics PC Diffuser	Thermally Conductive Plastics PC Diffuser	Thermally Conductive Plastics PC Diffuser
Dimensions	Φ121mm*132mm	Φ132mm*230mm	Φ125mm*279mm	Φ222mm*120mm



# LED T8 Tube

## Features

- High light transmittance
- Double-ended design
- Suitable for general lighting



## Specification

Model Name	LED-T85DGLR3	LED-T810DGLR3 LED-T810NGLR3 LED-T810WGLR3	LED-T820DGLR3 LED-T820NGLR3 LED-T820DGLR3	LED-T820BGLR2
Voltage Range	100-240V	100-240V	100-240V	100-240V
Driver	Internal	Internal	Internal	Internal
Power Consumption	<b>5W</b>	<b>10W</b>	<b>20W</b>	<b>20W</b>
Color Temperature	6500K±10%	6500K±10% (D) 4000K±10% (N) 3000K±10% (W)	6500K±10% (D) 4000K±10% (N) 3000K±10% (W)	<b>Blue Light</b> (wavelength 455~460nm)
Luminous Flux	500LM	1100LM (D) 1100LM (N) 1000LM (W)	2200LM (D) 2200LM (N) 2000LM (W)	880LM (N)
Color Rendering Index	≥ 80	≥ 80	≥ 80	≥ 80
Lifetime(hrs)	15000	15000	15000	15000
Field Angle	300°	300°	300°	300°
Body Material	Glass	Glass	Glass	Glass
Dimensions	Φ26mm*L330mm	Φ26mm*L580mm	Φ26mm*L1198mm	Φ26mm*L1198mm

# LED T5 Batten

## Features

- High light transmittance
- Enhanced gapless design (max 6 sets for one circuit)
- Suitable for cabinet, general lighting, indirect lighting



## Specification

Model Name	LED-T5BA1-DR5 LED-T5BA1-NR5 LED-T5BA1-WR5	LED-T5BA2-DR5 LED-T5BA2-NR5 LED-T5BA2-WR5	LED-T5BA3-DR5 LED-T5BA3-NR5 LED-T5BA3-WR5	LED-T5BA4-DR5 LED-T5BA4-NR5 LED-T5BA4-WR5
<b>Voltage Range</b>	100-240V	100-240V	100-240V	100-240V
<b>Driver</b>	Internal	Internal	Internal	Internal
<b>Power Consumption</b>	<b>5W</b>	<b>9W</b>	<b>14W</b>	<b>18W</b>
<b>Color Temperature</b>	6500K±10% (D) 4000K±10% (N) 3000K±10% (W)	6500K±10% (D) 4000K±10% (N) 3000K±10% (W)	6500K±10% (D) 4000K±10% (N) 3000K±10% (W)	6500K±10% (D) 4000K±10% (N) 3000K±10% (W)
<b>Luminous Flux</b>	400LM (D) 400LM (N) 360LM (W)	900LM (D) 900LM (N) 850LM (W)	1200LM (D) 1200LM (N) 1100LM (W)	1800LM (D) 1800LM (N) 1620LM (W)
<b>Color Rendering Index</b>	≥ 80	≥ 80	≥ 80	≥ 80
<b>Lifetime(hrs)</b>	15000	15000	15000	15000
<b>Field Angle</b>	170°	170°	170°	170°
<b>Body Material</b>	Thermally Conductive Plastics PC Diffuser	Thermally Conductive Plastics PC Diffuser	Thermally Conductive Plastics PC Diffuser	Thermally Conductive Plastics PC Diffuser
<b>Dimensions</b>	37mm*26mm*L300mm	37mm*26mm*L600mm	37mm*26mm*L900mm	37mm*26mm*L1182mm

# LED Panel Light

## Features

- Ultra-thin lamp body design
- High light transmittance and well-distributed lighting
- Suitable for office, school and other commercial applications



LED-PA40DR2  
LED-PA55DR2

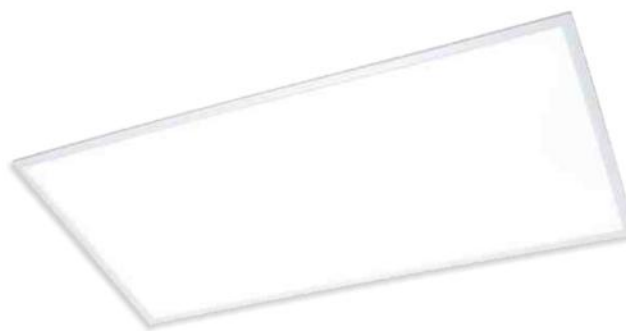

LED-PA80D



LED-PA40-FR

Ceiling-mount Fixture  
(for size 600\*600mm only)

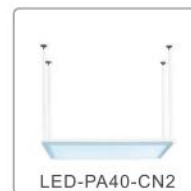

LED-PA40-CN2

Hanging string set  
(1 meter long strings)

## Specification

Model Name	LED-PA40DR2 LED-PA40NR2 LED-PA40WR2	LED-PA55DR2 LED-PA55WR2	LED-PA80D
Voltage Range	100-240V	100-240V	100-240V
Driver	External	External	External
Power Consumption	<b>40W</b>	<b>55W</b>	<b>80W</b>
Color Temperature	6250K (D) 4000K (N) 3000K (W)	6250K (D) 3000K (W)	6250K
Luminous Flux	3950LM (D) 3600LM (N) 3600LM (W)	5250LM (D) 5000LM (W)	7200LM
Color Rendering Index	≥ 80	≥ 80	≥ 80
Lifetime(hrs)	15000	15000	15000
Field Angle	160°	160°	160°
Body Material	Aluminum PC Diffuser	Aluminum PC Diffuser	Aluminum PC Diffuser
Dimensions (Driver:H50mm)	□600mm*H10mm	□600mm*H10mm	603mm*1213mm*H10mm



# LED Ceiling Recessed Light

## Features

- Ultra-thin lamp body design
- Suitable for office, school and other commercial applications



LED-2447R5



LED-2441R2

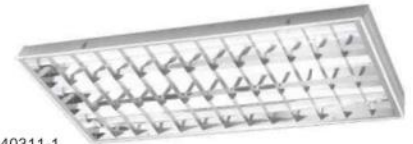

OF-40311-1

## Specification

Model Name	LED-2447R5 LED-2447WR5	LED-2441R2	OF-40311-1
Voltage Range	100-240V	—	—
Driver	External	—	—
Power Consumption	<b>36W</b>	Dancelight 10W 2ft LED tube *4pcs	Dancelight 20W 4ft LED tube *3pcs
Color Temperature	6000K (D) 3000K (W)	—	—
Luminous Flux	3100LM (D) 2800LM (W)	—	—
Color Rendering Index	≥ 80	—	—
Lifetime(hrs)	15000	—	—
Field Angle	165°	—	—
Body Material	Iron PC Diffuser	Steel Plate	Steel Plate
Dimensions	□600mm*H30mm	□601mm*H55mm	1220mm*600mm*H65mm

# LED T8 Tube Fixtures

## Features

- Applicable for double-ended led tubes
- Adopts solid materials and safe components



Type	Item No
Two 4ft tubes	LED-4243R5
One 4ft tube	LED-4143R3
Two 2ft tubes	LED-2243R3
One 2ft tube	LED-2143R3
One 1ft tube	LED-1143R3



Type	Item No
Two 4ft tubes	LED-42401
One 4ft tube	LED-41401

\*hanging installation is available



Type	Item No
One 4ft tube	LED-T8BA4-1
One 2ft tube	LED-T8BA2-1
One 1ft tube	LED-T8BA1-1



Type	Item No
Two 4ft tubes	LED-282003R1



Type	Item No
Two 4ft tubes	LED-402017
Two 2ft tube	LED-202019

## Specification

Model Name	LED-4243R5 LED-4143R3 LED-2243R3 LED-2143R3 LED-1143R3	LED-42401 LED-41401	LED-T8BA4-1 LED-T8BA2-1 LED-T8BA1-1	LED-282003R1	LED-402017 LED-202019
Body Material	Steel Plate	Steel Plate	Aluminum	Iron, PC	Iron, PC
Dimensions	L1243*W156*H60mm L1244*W110*H80mm L624*W156*H60mm L629*W110*H80mm L392*W132*H97mm	L1257*W182*H90mm L1257*W126*H83mm	L1241*W32*H90mm L619*W32*H90mm L392*W32*H90mm	L1336*W161*H54mm	L1435*W170*H80mm L825*W170*H80mm

# LED T8 Tube Fixtures

## Features

- Applicable for double-ended led tubes
- Adopts solid materials and safe components



LED-1104



LED-1102R1



LED-1103



LED-2105

with Cover

Type	Item No
E27 Bulb	LED-1104
One 1ft tube	LED-1102R1
One 1ft tube	LED-1103
One 1ft tube	LED-2105

## Specification

Model Name	LED-1104	LED-1102R1	LED-1103	LED-2105
Body Material	Stainless steel , PC	Iron, PC	Iron, PC	Iron, PC
Dimensions	L300mm*W110mm*H95mm	L400mm*W110mm*H80mm	L400mm*W107mm*H98mm	L655mm*W140mm*H95mm



# LED T8 Tube Fixtures

## Features

- Applicable for double-ended led tubes
- IP66 can be installed in outdoor application
- Ceiling hanging installation is available



## Damp-Proof

Type	Item No
Two 4ft tubes	OD-T8WA4*2-1
One 4ft tube	OD-T8WA4*1-1
Two 2ft tubes	OD-T8WA2*2-1
One 2ft tube	OD-T8WA2*1-1

## Specification

Model Name	OD-T8WA4*2-1	OD-T8WA4*1-1	OD-T8WA2*2-1	OD-T8WA2*1-1
Body Material	Stainless steel , PC	Stainless steel , PC	Stainless steel , PC	Stainless steel , PC
Dimensions	L1260mm*W110mm*H90mm	L1260mm*W70mm*H90mm	L660mm*W110mm*H90mm	L660mm*W70mm*H90mm



 DANCELIGHT

OUTDOOR





# LED Outdoor Wall Light

## Features

- Simple design suitable for different styles
- High colour rendering index ra80+
- High quality die-casting aluminum material is applied



## Specification

Model Name	OD-2295	OD-2278R1
Voltage Range	100-240V	100-240V
Driver	Included (waterproof driver)	Included (waterproof driver)
Power Consumption	4W	4W
Color Temperature	3000K±10%	3000K±10%
Luminous Flux	90LM	90LM
Color Rendering Index	≥ 80	≥ 80
Lifetime(hrs)	15000	15000
Body Material	Die-casting Aluminum, PC	Die-casting Aluminum, PC
Dimensions	Φ148mm*H37mm	148mm*148mm*H37mm



# LED Outdoor Wall Light

## Features

- Simple design suitable for different styles
- High colour rendering index ra80+
- High quality die-casting aluminum material is applied

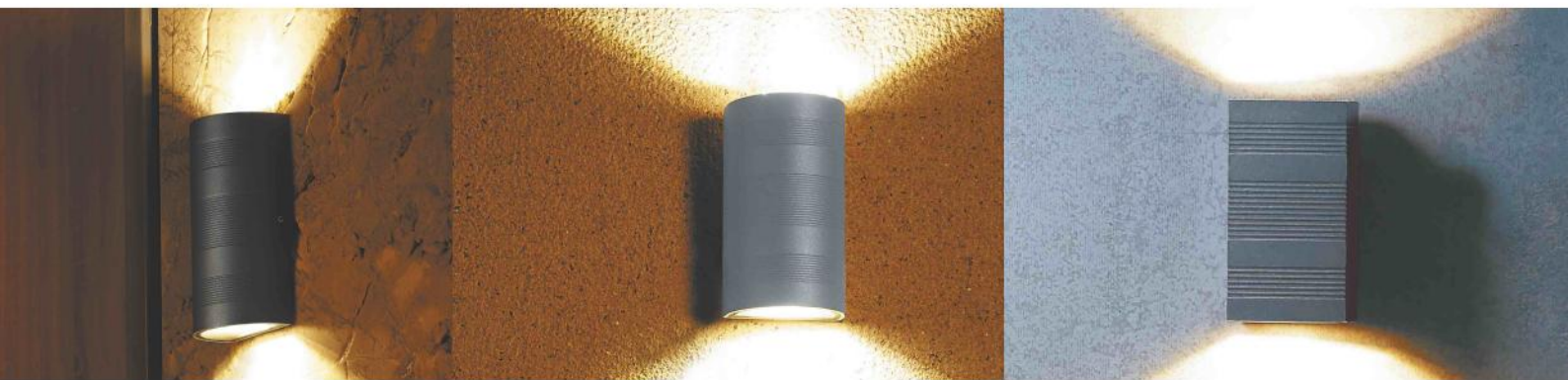

**CREE CHIPS**  
OD-2262R1



**CREE CHIPS**  
OD-2279



**CREE CHIPS**  
OD-2281

## Specification

Model Name	OD-2262R1	OD-2279	OD-2281
Voltage Range	100-240V	100-240V	100-240V
Driver	Included (waterproof driver)	Included (waterproof driver)	Included (waterproof driver)
Power Consumption	13W	13W	13W
Color Temperature	3000K±10%	3000K±10%	3000K±10%
Luminous Flux	800LM	800LM	800LM
Color Rendering Index	≥ 80	≥ 80	≥ 80
Lifetime(hrs)	15000	15000	15000
Body Material	Die-casting Aluminum, Glass	Die-casting Aluminum, Glass	Die-casting Aluminum, Glass
Dimensions	W90mm*H160mm*D55mm	W90mm*H160mm*D55mm	W90mm*H160mm*D55mm

# LED Outdoor Wall Light

## Features

- Simple design suitable for different styles
- High colour rendering index ra80+
- High quality die-casting aluminum material is applied

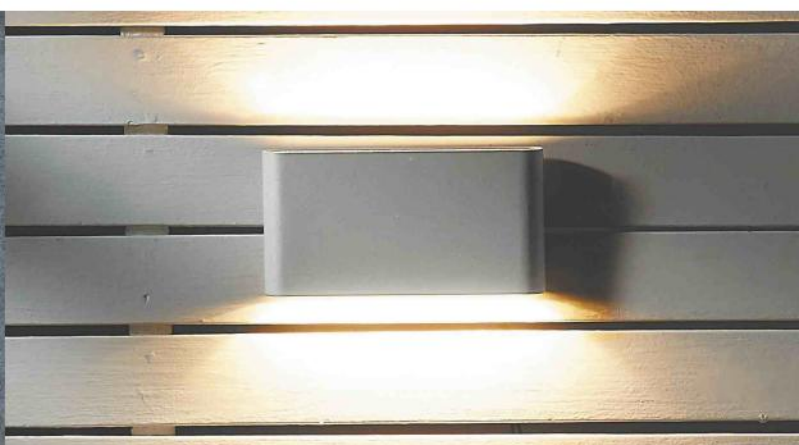
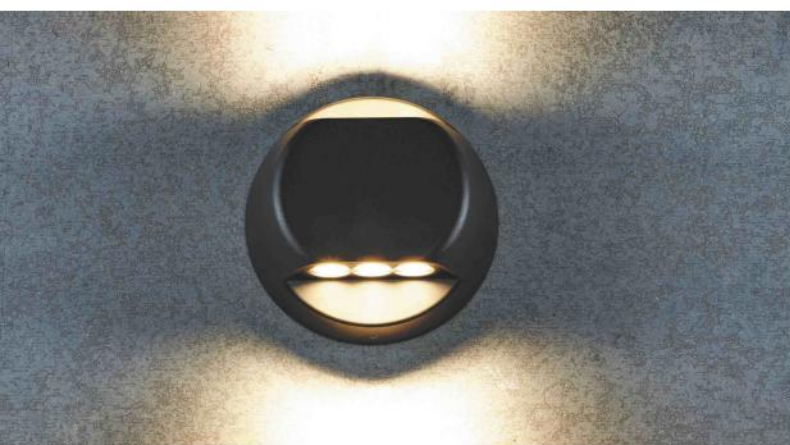

**CREE CHIPS**  
OD-2249



**EVERLIGHT CHIPS**  
OD-2276

## Specification

Model Name	OD-2249	OD-2276
Voltage Range	100-240V	100-240V
Driver	Included (waterproof driver)	Included (waterproof driver)
Power Consumption	8W	13W
Color Temperature	3000K±10%	3000K±10%
Luminous Flux	400LM	750LM
Color Rendering Index	≥ 80	≥ 80
Lifetime(hrs)	15000	15000
Body Material	Die-casting Aluminum, Glass	Die-casting Aluminum, Glass
Dimensions	Φ140mm*H60mm	W90mm*H175mm*D29mm

# LED Outdoor Wall Light

## Features

- Simple design suitable for different styles
- High colour rendering index ra80+
- High quality die-casting aluminum material is applied



**CREE CHIPS**  
OD-2260



**CREE CHIPS**  
OD-2280

## Specification

Model Name	OD-2260	OD-2280
Voltage Range	100-240V	100-240V
Driver	Included (waterproof driver)	Included (waterproof driver)
Power Consumption	<b>4W</b>	<b>13W</b>
Color Temperature	3000K±10%	3000K±10%
Luminous Flux	250LM	700LM
Color Rendering Index	≥ 80	≥ 80
Lifetime(hrs)	15000	15000
Body Material	Die-casting Aluminum, Glass	Die-casting Aluminum, Glass
Dimensions	W150mm*H100mm*D60mm	W150mm*H130mm*D60mm



# LED Outdoor Wall Light

## Features

- Simple design suitable for different styles
- High colour rendering index ra80+
- High quality die-casting aluminum material is applied



**OSRAM CHIPS**  
OD-2263



**EVERLIGHT CHIPS**  
OD-2282



**EVERLIGHT CHIPS**  
OD-2294

## Specification

Model Name	OD-2263	OD-2282	OD-2294
Voltage Range	100-240V	100-240V	100-240V
Driver	Included (waterproof driver)	Included (waterproof driver)	Included (waterproof driver)
Power Consumption	8W	13W	13W
Color Temperature	3000K±10%	3000K±10%	3000K±10%
Luminous Flux	210LM	430LM	320LM
Color Rendering Index	≥ 80	≥ 80	≥ 80
Lifetime(hrs)	15000	15000	15000
Body Material	Die-casting Aluminum, PC cover	Die-casting Aluminum, PC cover	Die-casting Aluminum, PC cover
Dimensions	W145mm*H240mm*D70mm	W140mm*H270mm*D100mm	W160mm*H200mm*D38.5mm

# LED Outdoor Wall Light

## Features

- Simple design suitable for different styles
- High colour rendering index ra80+
- High quality die-casting aluminum material is applied



**EPISTAR CHIPS**  
OD-2272



**EPISTAR CHIPS**  
OD-2273

## Specification

Model Name	OD-2272	OD-2273
Voltage Range	100-240V	100-240V
Driver	Included (waterproof driver)	Included (waterproof driver)
Power Consumption	<b>10W</b>	<b>10W</b>
Color Temperature	3000K±10%	3000K±10%
Luminous Flux	500LM	480LM
Color Rendering Index	≥ 80	≥ 80
Lifetime(hrs)	15000	15000
Body Material	Die-casting Aluminum, PC cover	Die-casting Aluminum, PC cover
Dimensions	Φ155mm*H47mm	W118mm*H218mm*D38mm



# LED Outdoor Lawn Light

## Features

- Simple design suitable for different styles
- High colour rendering index ra80+
- High quality die-casting aluminum material is applied



## Specification

<b>Model Name</b>	OD-3176	OD-3178	OD-3168R1 (80cm) OD-3150R1 (50cm) OD-3159R1 (30cm)
<b>Voltage Range</b>	100-240V	100-240V	100-240V
<b>Driver</b>	Included (waterproof driver)	Included (waterproof driver)	Included (waterproof driver)
<b>Power Consumption</b>	<b>9W</b>	<b>6W</b>	<b>9W</b>
<b>Color Temperature</b>	3000K±10%	3000K±10%	3000K±10%
<b>Luminous Flux</b>	360LM	350LM	275LM
<b>Color Rendering Index</b>	≥ 80	≥ 80	≥ 80
<b>Lifetime(hrs)</b>	15000	15000	15000
<b>Body Material</b>	Die-casting Aluminum, PC cover	Die-casting Aluminum, PC cover	Die-casting Aluminum, PC cover
<b>Dimensions</b>	W130mm*H500mm*D80mm	W130mm*H500mm*D80mm	W123mm*123mm*H800mm W123mm*123mm*H500mm W123mm*123mm*H300mm



# LED Garden Spotlight

## Features

- High colour rendering index ra80+
- High quality die-casting aluminum material is applied
- Suitable for 7 meters high wall (beam angle 15°)



## Specification

Model Name	OD-3174	OD-3177 (35°) OD-3177SP (15°)
Voltage Range	100-240V	100-240V
Driver	Internal (waterproof driver)	Internal (waterproof driver)
Power Consumption	9W	18W
Color Temperature	3000K±10%	3000K±10%
Luminous Flux	700LM	1450LM
Color Rendering Index	≥ 80	≥ 80
Lifetime(hrs)	15000	15000
Beam Angle	30°	35° / 15°
IP Rating	IP66	IP66
Body Material	Die-casting Aluminum, Tempered Glass	Die-casting Aluminum, Tempered Glass
Dimensions	Φ120mm*H141mm*D90mm	Φ120mm*H141mm*D90mm

# LED Garden Spotlight

## Features

- Simple design suitable for different styles
- High colour rendering index ra80+
- High quality die-casting aluminum material is applied



OD-3162  
**CREE CHIPS**



OD-3175  
**CREE CHIPS**



OD-10009-FT (surface type)



OD-10011-FT (plug-in type)

## Specification

Model Name	OD-3162	OD-3175	OD-10009-FT (surface type) OD-10011-FT (plug-in type)
Voltage Range	100-240V	100-240V	100-240V
Driver	Internal (waterproof driver)	Internal (waterproof driver)	Internal (waterproof driver)
Power Consumption	<b>8W</b>	<b>6W</b>	<b>9W</b>
Color Temperature	3000K±10%	3000K±10%	3000K±10%
Luminous Flux	500LM	380LM	600LM
Color Rendering Index	≥ 80	≥ 80	≥ 75
Lifetime(hrs)	15000	15000	15000
Beam Angle	30°	36°	15°
IP Rating	IP66	IP66	--
Body Material	Die-casting Aluminum	Die-casting Aluminum	Die-casting Aluminum
Dimensions	Φ100mm*W150mm*H468mm	Φ92mm*H315mm	Φ90*H195mm Φ90*H320mm

# LED Floodlight

## Features

- Wider turning angle of 300 degrees
- Enhanced multiple water proof design
- High quality die-casting aluminum material is applied

**IP66**



OD-FL300D  
**CREE CHIPS**

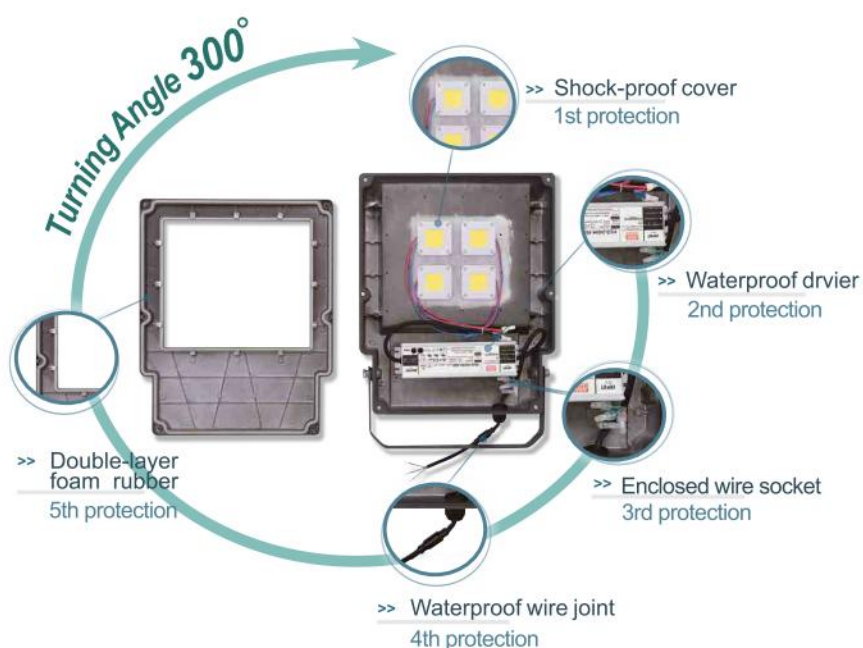

## Specification

Model Name	OD-FL300D
Voltage Range	100-277V
Driver	Internal (MeanWell driver)
Power Consumption	<b>300W</b>
Color Temperature	6000K±10%
Luminous Flux	39000LM
Color Rendering Index	≥ 70
Lifetime(hrs)	15000
Field Angle	100°
IP Rating	IP66
Body Material	Die-casting Aluminum, Tempered Glass
Dimensions	W418mm*H558mm*D133mm



# LED Wall Washer Light

## Features

- Wider turning angle of 300 degrees
- Enhanced multiple water proof design
- High quality die-casting aluminum material is applied



OD-FL200DR2

OD-FL120DR2

## Specification

Model Name	OD-FL200DR2	OD-FL120DR2 OD-FL120WR2
Voltage Range	100-277V	100-277V
Driver	Internal (MeanWell driver)	Internal (waterproof driver)
Power Consumption	<b>200W</b>	<b>120W</b>
Color Temperature	6000K±10%	6000K±10% (D) 3000K±10% (W)
Luminous Flux	20000LM	11800LM (D) 9900LM (W)
Color Rendering Index	≥ 70	≥ 70
Lifetime(hrs)	25000	15000
Field Angle	120°	140°
IP Rating	IP66	IP66
Body Material	Die-casting Aluminum, Tempered Glass	Die-casting Aluminum, Tempered Glass
Dimensions	W376mm*H529mm*D67mm	W303mm*H439mm*D60mm

# LED Wall Washer Light

## Features

- Wider turning angle of 300 degrees
- Enhanced multiple water proof design
- High quality die-casting aluminum material is applied



OD-FL50D

OD-FL30D

OD-FL20D

OD-FL10D

## Specification

Model Name	OD-FL50D OD-FL50W	OD-FL30D OD-FL30W	OD-FL20D OD-FL20W	OD-FL10D OD-FL10W
<b>Voltage Range</b>	100-240V	100-240V	100-240V	100-240V
<b>Driver</b>	Internal (waterproof driver)	Internal (waterproof driver)	Internal (waterproof driver)	Internal (waterproof driver)
<b>Power Consumption</b>	<b>50W</b>	<b>30W</b>	<b>20W</b>	<b>10W</b>
<b>Color Temperature</b>	6000K±10% (D) 3000K±10% (W)	6000K±10% (D) 3000K±10% (W)	6000K±10% (D) 3000K±10% (W)	6000K±10% (D) 3000K±10% (W)
<b>Luminous Flux</b>	4600LM (D) 4100LM (W)	2500LM (D) 2200LM (W)	1600LM (D) 1430LM (W)	750LM (D) 680LM (W)
<b>Color Rendering Index</b>	≥ 70	≥ 70	≥ 70	≥ 70
<b>Lifetime(hrs)</b>	15000	15000	15000	15000
<b>Field Angle</b>	140°	140°	140°	140°
<b>IP Rating</b>	IP66	IP66	IP66	IP66
<b>Body Material</b>	Die-casting Aluminum Tempered Glass	Die-casting Aluminum Tempered Glass	Die-casting Aluminum Tempered Glass	Die-casting Aluminum Tempered Glass
<b>Dimensions</b>	W217mm*H331mm*D45mm	W172mm*H264mm*D45mm	W149mm*H228mm*D42mm	W121mm*H184mm*D35mm

# LED Microwave Sensor Light

## Features

- Sensing time and distance are adjustable
- High sensitive microwave sensor
- High quality die-casting aluminum material is applied



### Operation Guide



## Specification

<b>Model Name</b>	OD-SEFL12DR1 OD-SEFL12WR1	OD-SEFL24DR1 OD-SEFL24WR1
<b>Voltage Range</b>	100-240V	100-240V
<b>Driver</b>	Internal (waterproof driver)	Internal (waterproof driver)
<b>Power Consumption</b>	<b>12W</b>	<b>24W</b>
<b>Color Temperature</b>	6000K±10% (D) 3000K±10% (W)	6000K±10% (D) 3000K±10% (W)
<b>Luminous Flux</b>	710LM (D) 680LM (W)	1750LM (D) 1540LM (W)
<b>Color Rendering Index</b>	≥ 70	≥ 70
<b>Lifetime(hrs)</b>	15000	15000
<b>Field Angle</b>	120°	120°
<b>IP Rating</b>	IP66	IP66
<b>Body Material</b>	Die-casting Aluminum, Tempered Glass	Die-casting Aluminum, Tempered Glass
<b>Dimensions</b>	W155mm*H168mm*D95mm	W178mm*H213mm*D100mm



# LED Microwave Ceiling Sensor Light

## Features

- High colour rendering index ra80+
- Sensing time and distance are adjustable
- High sensitive microwave sensor



## Operation Guide

### Time Adjustable



### Distance Adjustable

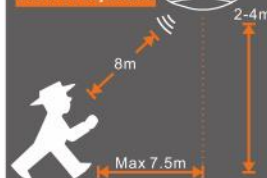

## Specification

Model Name	OD-CE16DSE OD-CE16WSE
Voltage Range	100-240V
Driver	Internal
Power Consumption	16W
Color Temperature	6250K±10% (D) 3000K±10% (W)
Luminous Flux	1400LM (D) 1300LM (W)
Color Rendering Index	≥ 80
Lifetime(hrs)	15000
Field Angle	140°
IP Rating	IP66
Body Material	PC
Dimensions	Φ300mm*H87mm

# LED Street Light

## Features

- Enhanced Heat-sink for better lumen maintenance
- High colour rendering index ra70+
- High quality die-casting aluminum material is applied



CL-01A (Φ38mm)  
the holding pole is purchased separately

## Specification

Model Name	OD-10072R1	OD-10071R1 OD-10071WR1
Voltage Range	100-240V	100-240V
Driver	Internal (MeanWell driver)	Internal
Power Consumption	<b>100W</b>	<b>60W</b>
Color Temperature	6500K±10%	6500K±10% (D) 3000K±10% (W)
Luminous Flux	12000LM	4560LM (D) 4300LM (W)
Color Rendering Index	≥ 70	≥ 70
Lifetime(hrs)	15000	15000
Field Angle	130°	200°
IP Rating	IP66	IP66
Body Material	Die-casting Aluminum, Tempered Glass	Die-casting Aluminum, Tempered Glass
Dimensions	W280mm*H720mm*D120mm	W262mm*H530mm*D155mm

# LED High Bay Light

## Features

- Meanwell driver is applied for more stable performance
- High efficiency PHILIPS LED can provide higher lumen output
- High quality die-casting aluminum material is applied



LED-HIBAY100CN2  
LED-HIBAY150CN2  
LED-HIBAY200CN2  
the ceiling rack is not included in the package which is purchasable individually

## Specification

Model Name	LED-HIBAY100DR2	LED-HIBAY150DR2	LED-HIBAY200DR2	LED-HIBAY240DR2
Voltage Range	100-277V	100-277V	100-277V	100-277V
Driver	Internal (waterproof MW driver)	Internal (waterproof MW driver)	Internal (waterproof MW driver)	Internal (waterproof MW driver)
Power Consumption	<b>100W</b>	<b>150W</b>	<b>200W</b>	<b>240W</b>
Color Temperature	6250K	6250K	6250K	6250K
Luminous Flux	13000LM	19500LM	26000LM	31200LM
Color Rendering Index	≥ 80	≥ 80	≥ 80	≥ 80
Lifetime(hrs)	15000	15000	15000	15000
Field Angle	120°	120°	120°	120°
IP Rating	IP66	IP66	IP66	IP66
Body Material	Die-casting Aluminum PC cover	Die-casting Aluminum PC cover	Die-casting Aluminum PC cover	Die-casting Aluminum PC cover
Dimensions	Φ300mm*H189mm	Φ346mm*H203mm	Φ400mm*H225mm	Φ400mm*H225mm



# LED High Bay Light

## Features

- Narrow angle can give stronger lux
- Bigger heat-sink is used for more stable performance
- High quality die-casting aluminum material is applied



## Specification

Model Name	LED-HIBAY150WSP	LED-HIBAY200WSP
Voltage Range	100-277V	100-277V
Driver	Internal (MW driver)	Internal (MW driver)
Power Consumption	<b>150W</b>	<b>200W</b>
Color Temperature	6250K	6250K
Luminous Flux	14050LM	16250LM
Color Rendering Index	≥ 70	≥ 70
Lifetime(hrs)	25000	25000
Field Angle	80°	80°
IP Rating	IP65	IP65
Body Material	Aluminum	Aluminum
Dimensions	Φ500mm*H385mm	Φ500mm*H410mm

# LED Underground Light

## Features

- Simple design suitable for different styles
- Stainless steel material is applied



OD-4135W

  $\Phi 98\text{mm}$



OD-4123BR3



OD-4123WR3

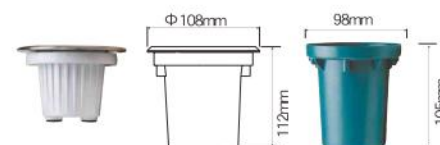
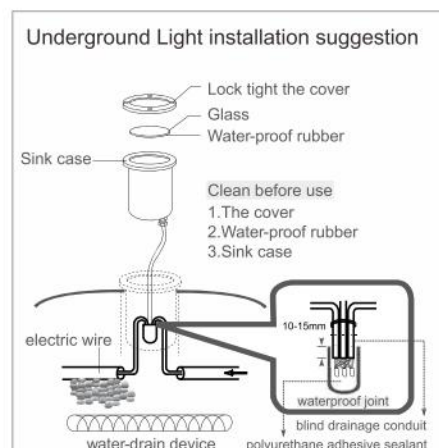

## Specification

Model Name	OD-4135W	OD-4123BR3 OD-4123WR3
Voltage Range	100-240V	100-240V
Driver	Internal (waterproof driver)	Internal (waterproof driver)
Power Consumption	4W	1.2W
Color Temperature	3000K $\pm$ 10%	Blue Light (B) 3000K $\pm$ 10% (W)
Luminous Flux	150LM	30LM (B) 75LM (W)
Color Rendering Index	$\geq 80$	$\geq 80$ (W)
Lifetime(hrs)	15000	15000
Field Angle	45°	30°
IP Rating	IP66	IP66
Body Material	Stainless steel, Glass, PC Case	Stainless steel, Glass, PC Case
Dimensions	$\Phi 108\text{mm} \times \text{H}112\text{mm}$	$\Phi 108\text{mm} \times \text{H}112\text{mm}$
Installation Size	$\Phi 98\text{mm} \times \text{H}105\text{mm}$	$\Phi 98\text{mm} \times \text{H}105\text{mm}$

# LED Step/Stair Light

## Features

- Simple design suitable for different styles
- Integrated design, easy install



OD-4132



OD-4133



## Specification

Model Name	OD-4132	OD-4133
Voltage Range	110-240V	110-240V
Driver	Internal (waterproof driver)	Internal (waterproof driver)
Power Consumption	1.6W	1.6W
Color Temperature	Blue Light (B)	3000K±10%
Luminous Flux	--	90LM
Lifetime(hrs)	15000	15000
IP Rating	IP66	IP66
Body Material	Stainless steel, Glass, PC Case	Stainless steel, Glass, PC Case
Dimensions	W135mm*L75mm*H31mm	W135mm*L75mm*H31mm



# LED DC Light Strip

## Features

- 10 meters at most for one circuit
- Every 5cm can be cut
- Meanwell driver is purchasable individually



## Specification

<b>Model Name</b>	LED-35NA12V-DR2 LED-35NA12V-WR2 LED-35NA12V-BR2	LED-50NA12V-D LED-50NA12V-W LED-50NA12V-B LED-50NA12V-RGB	LED-35WO12V-DR3 LED-35WO12V-WR3 LED-35WO12V-BR3 LED-35WO12V-RR3	LED-50WO12V-DR3 LED-50WO12V-WR3
<b>Voltage Range</b>	12V DC	12V DC	12V DC	12V DC
<b>Driver</b>	Not included	Not included	Not included	Not included
<b>Power Consumption</b>	<b>20W</b>	<b>40W</b>	<b>20W</b>	<b>40W</b>
<b>Color Temperature</b>	White light (D) Warm white (W) Blue (B)	White light (D) Warm white (W) Blue (B) RGB	White light (D) Warm white (W) Blue (B) Red light (R)	White light (D) Warm white (W)
<b>Luminous Flux</b>	350 LM/ meter	700 LM/ meter	350 LM/ meter	700 LM/ meter
<b>Lifetime(hrs)</b>	15000	15000	20000	20000
<b>Field Angle</b>	120°	120°	120°	120°
<b>IP Rating</b>	-	-	IP66	IP66
<b>Body Material</b>	Copper plate	Copper plate	Silicon, Copper plate	Silicon, Copper plate
<b>Dimensions</b>	L5000mm*W8mm*H2mm	L5000mm*W10mm*H2mm	L5000mm*W10.5mm*H5mm	L5000mm*W12.5mm*H5mm

# LED AC Light Strip

## Features

- 50 meters connection at most for 110V(3528); 25 meters connection at most for 220V and 110V(5050/RGB).
- Every 100cm (220V) / 50cm (110V) can be cut



## Specification

Model Name	LED-35HV/1-DD LED-35HV/1-DW	LED-35HV/1-D LED-35HV/1-W LED-35HV/1-B	LED-50HV/1-W	LED-50HV/2-D LED-50HV/2-W LED-50HV/2-B LED-50HV/2-RGB
Voltage Range	110V	110V	110V	220V
Driver	Included	Included	Included	Included
Power Consumption	195W (15m)	120W (25m)	120W (25m)	360W(25m) 288W(20m - RGB)
Color Temperature	White light (D) Warm white (W)	White light (D) Warm white (W) Blue (B)	Warm white (W)	White light (D) Warm white (W) Blue (B) RGB
Lifetime(hrs)	15000	20000	20000	20000
Field Angle	120°	120°	120°	120°
Body Material	PVC, Copper plate	PVC, Copper plate	PVC, Copper plate	PVC, Copper plate
Dimensions	L15000mm*W18mm*H8mm	L25000mm*W10mm*H7mm	L25000mm*W14mm*H7mm	L5000mm*W14mm*H7mm L5000mm*W16mm*H5mm (RGB)





© DANCELIGHT  
LED

15<sup>th</sup>  
EDITION



# Brand Value • Diverse • Quality • Affordable



Jan Cheng Lighting Co., Ltd. was established in 1987. We are Taiwan's leading lighting supplier. With 40 years of experience in lighting application and marketing, we created DanceLight in 2008. DanceLight is now Taiwan's leading LED lighting brand in terms of the market share.

We provide diverse, quality, and affordable LED lighting products to customers. Our LED lighting products can be used in commercial, residential, outdoor and industrial applications. Which, in turn, covers over more than 400 items listed in this catalogue, includes retrofits, indoor and outdoor lights.

## A Total Solution for Lighting



Taiwan Head Office

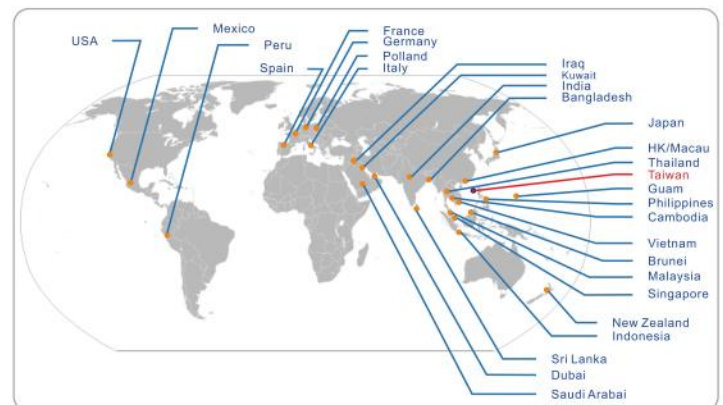

Sales Network

# DANCELIGHT

Taiwan's Leading Lighting Brand



Product Display Shelves



Diverse  
Quality  
Affordable



## | Office/School



Panel Light ——— **001**



T5 Batten ——— **004**



Decor Fixture ——— **005**



Damp-Proof Fixture **010**

## | Commercial



Track Spotlight — **012**



Ceiling-mounted Downlight **021**



Commercial Downlight **027**



Downlight ——— **039**

## | Residential



Ceiling Mounted Light **042**



Pendant Lamp ——— **052**



Bedside Lamp ——— **054**



Wall Light ——— **058**



Desk Lamp ——— **064**

## | LED Retrofit



E27 Bulb ——— **066**



High Power Bulb ——— **068**





Filament Bulb — **073**



AR111 — **074**



MR16 — **076**



T8 Tube — **078**

## | Outdoor



Wall Light — **081**



Lawn Light — **087**



Garden Spotlight **095**



Stair Light — **099**



Flood Light — **103**



Sensor Light — **107**



Street Light — **109**

## | Industrial



High Bay Light **110**



Linear High Bay Light **111**

## | Others



Lightstrip — **112**



LED Emergency Light **116**



LED Driver — **117**

# Ultra-thin Panel Light



# Ultra-thin Edge Back-lit Panel Light



72W



40W/ 50W

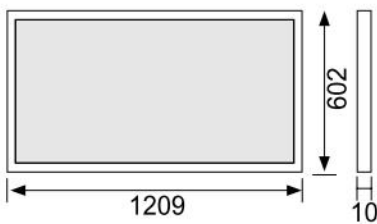
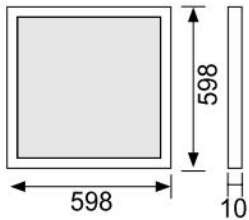

LED-PA40R6-CN1  
40、50、72W  
hanging wire (1.2 meters)



LED-PA40-FR1 (2x2 尺)  
LED-PA72-FR (4x2 尺)

Item Code	Power	Voltage	CCT	Lumen	CRI	Material
LED-PA72DR6	72W	100V   240V	6000K	7200LM	≥ 80	Aluminum 2mm PMMA Diffuser
LED-PA50DR6	50W		6000K	5000LM		
LED-PA50WR6			3000K			
LED-PA40DR6	40W		6000K	4000LM		
LED-PA40NR6			4000K			
LED-PA40WR6			3000K			



# Direct Back-lit Panel Light



Safety Fixing Gear



PS Diffuser



Solid Material



Fast Connector

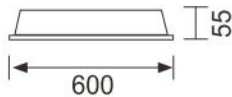
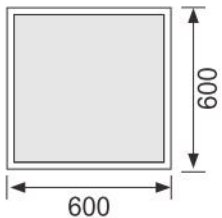

YouTube Clip

Item Code	Power	Voltage	CCT	Lumen	CRI	Material
LED-PD40D	40W	100V   240V	6250K	3400LM	≥ 80	Aluminum, Iron PS Diffuser
LED-PD40N			4000K	3400LM		
LED-PD40W			3000K	3060LM		

# LED T5 Batten

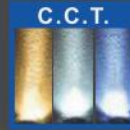

LED-T5BA-PCDR1  
connection cable is not included



YouTube Clip

Item Code	Power	Voltage	CCT	Lumen	CRI	Field Angle	Material	Dimensions									
LED-T5BA1-DR6	5W	100V   240V	6500K	400LM	≥ 80	210°	Thermally- Conductive Plastic	W:300mm D:26mm H:37mm									
LED-T5BA1-NR6			4000K	400LM													
LED-T5BA1-WR6			3000K	360LM													
LED-T5BA2-DR6	9W		6500K	900LM				≥ 80	210°	Thermally- Conductive Plastic	W:600mm D:26mm H:37mm						
LED-T5BA2-NR6			4000K	900LM													
LED-T5BA2-WR6			3000K	850LM													
LED-T5BA3-DR6	14W		6500K	1200LM							≥ 80	210°	Thermally- Conductive Plastic	W:900mm D:26mm H:37mm			
LED-T5BA3-NR6			4000K	1200LM													
LED-T5BA3-WR6			3000K	1100LM													
LED-T5BA4-DR6	18W		6500K	1800LM										≥ 80	210°	Thermally- Conductive Plastic	W:1182mm D:26mm H:37mm
LED-T5BA4-NR6			4000K	1800LM													
LED-T5BA4-WR6			3000K	1620LM													

# LED Tube Fixture



LED-4231

\*ceiling-mounted is available



LED-4131

\*ceiling-mounted is available

Item Code	Applicable Lights	Material	Dimensions
LED-4231	LED T8 4FT X2	Wood	L: 1460mm D: 150mm H: 130mm
LED-4131	LED T8 4FT X1		L: 1460mm D: 90mm H: 130mm

\*not include tubes



# LED Tube Fixture



LED-4117



LED-4118

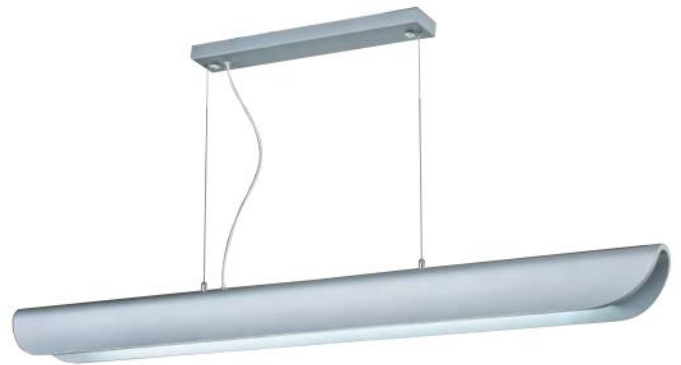

LED-4119

Item Code	Applicable Lights	Material	Dimensions
LED-4117	LED T8 4FT X1	Wood \ Original colour	L: 1460mm D: 130mm H: 130mm
LED-4118		Wood \ Black colour	
LED-4119		Wood \ Silver colour	

\*not include tubes

# LED Tube Fixture



LED-4132



LED-4220

\*ceiling-mounted is available

Item Code	Applicable Lights	Material	Dimensions
LED-4132	LED T8 4FT X1	Wood \ Iron	L: 1265mm D: 60mm H: 100mm
LED-4220	LED T8 4FT X2	Wood \ Acrylic	L: 1260mm D: 150mm H: 100mm

\*not include tubes

# LED Tube Fixture



LED-4222



LED-4124

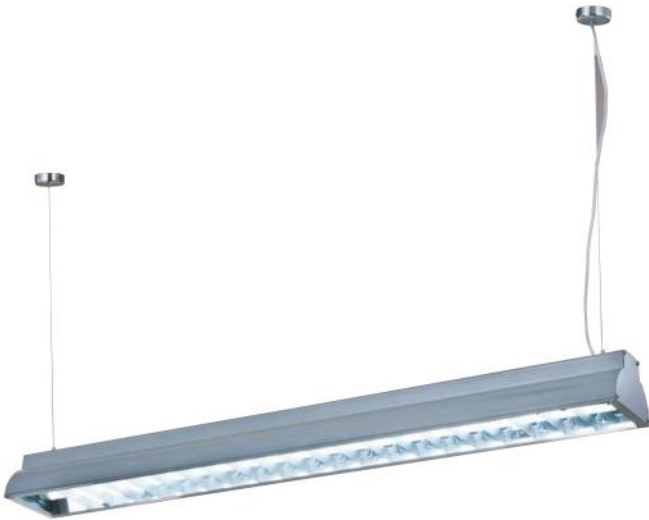

LED-4223



LED-4125

Item Code	Applicable Lights	Material	Dimensions
LED-4222	LED T8 4FT X2	Aluminum	L: 1250mm D: 140mm H: 100mm
LED-4124	LED T8 4FT X1	Aluminum 、 Acrylic	L: 1250mm D: 70mm H: 80mm
LED-4223	LED T8 4FT X2	Aluminum	L: 1250mm D: 140mm H: 100mm
LED-4125	LED T8 4FT X1	Aluminum 、 Acrylic	L: 1250mm D: 70mm H: 80mm

\*not include tubes



# LED Tube Fixture



LED-4227



LED-4229



LED-4228



LED-4230

Item Code	Applicable Lights	Material	Dimensions
LED-4227	LED T8 4FT X2	Aluminum \ Acrylic	L: 1250mm D: 250mm H: 60mm
LED-4229			L: 1240mm D: 140mm H: 270mm
LED-4228			L: 1250mm D: 250mm H: 60mm
LED-4230			L: 1240mm D: 140mm H: 270mm

\*not include tubes

# Damp-proof Tube Fixture



OD-T8WA4\*2-1 (4 ft)

OD-T8WA2\*2-1 (2 ft)



OD-T8WA4 \* 1-1 (4 ft)

OD-T8WA2 \* 1-1 (2 ft)

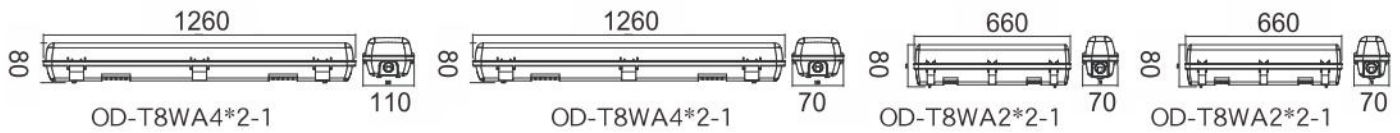

Item Code	Applicable Lights	Material
OD-T8WA4 * 2-1	LED T8 4FT X2	Stainless Parts 、 PC (Hanging installation is available)
OD-T8WA2 * 2-1	LED T8 2FT X2	
OD-T8WA4 * 1-1	LED T8 4FT X1	
OD-T8WA2 * 1-1	LED T8 2FT X1	

\*not include tubes

# SMART Dimmable Series

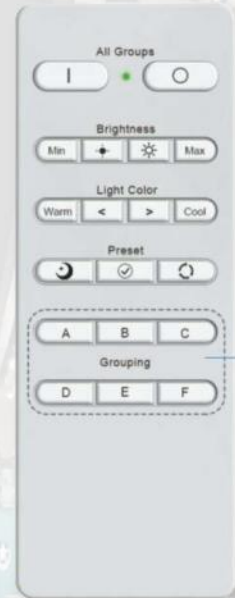

Non-flicker Driver comfortable to your eyes

Taiwanese dual-colour COB LED  
8-stage dimming (64 combinations)

2.4GHz. RF Controller  
able to have synchronous signal in separate circuit



LED-TR30DMFL(P55)



LED-CEB40DM (P47)



LED-CEB30DM (P48)



LED-24"DOD40DM (P55)  
LED-24"DOD30DM



LED-21"DOD40DM (P56)  
LED-21"DOD30DM



LED-25124DM (P57)



# 45W RA90 Tracklight

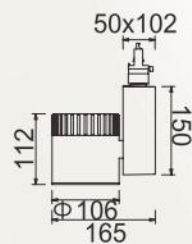

Item Code		Power	Voltage	CCT	Lumen	CRI	Beam Angle	Material
White	Black							
LED-TR30DMFL	LED-TR30MFL-BK	30W	100 V   240V	3000K~6500K	200-2100LM	≥ 80	30°	Die-casting Aluminum 、 Glass
LED-TR45DFL	LED-TR45DFL-BK	45W		5000K	3600LM	≥ 80		
LED-TR45NFL	LED-TR45NFL-BK			4000K	3100LM	≥ 90, R9>50		
LED-TR45WFL	LED-TR45WFL-BK			3000K	3100LM			

# 30W RA90 Tracklight

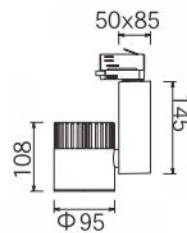
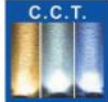

Item Code		Power	Voltage	CCT	Lumen	CRI	Beam Angle	Material
White	Black							
LED-TR30DFL	LED-TR30DFL-BK	30W	100 V   240V	5000K	2400LM	$\geq 80$	24°	Die-casting Aluminum 、 Glass
LED-TR30NFL	LED-TR30NFL-BK			4000K	2050LM	$\geq 90,$ R9>50		
LED-TR30WFL	LED-TR30WFL-BK			3000K	2050LM			

# 24W RA90 Tracklight

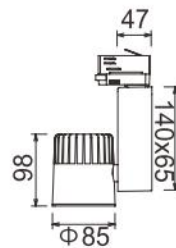

Item Code		Power	Voltage	CCT	Lumen	CRI	Beam Angle	Material
White	Black							
LED-TR24DFL	LED-TR24DFL-BK	24W	100V   240V	6000K	1500LM	≥ 80	45°	Die-casting Aluminum 、 Glass
LED-TR24NFL	LED-TR24NFL-BK			4000K	1200LM	≥ 90, R9>50		
LED-TR24WFL	LED-TR24WFL-BK			3000K	1200LM			



# 12W RA90 Tracklight

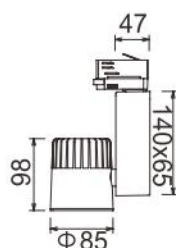

Item Code		Power	Voltage	CCT	Lumen	CRI	Beam Angle	Material
White	Black							
LED-TR12DFL	LED-TR12DFL-BK	12W	100 V   240V	6000K	900LM	≥ 80	45°	Die-casting Aluminum 、 Glass
LED-TR12NFL	LED-TR12NFL-BK			4000K	700LM	≥ 90, R9>50		
LED-TR12WFL	LED-TR12WFL-BK			3000K	700LM			

# 8W Tracklight

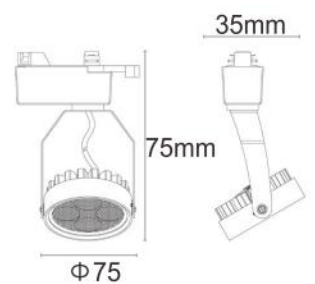

Item Code		Power	Voltage	CCT	Lumen	CRI	Beam Angle	Material
White	Black							
LED-TRSM8D	LED-TRSM8D-BK	8W	100 V   240V	6000K	750LM	≥ 80, R9>0	25°	Aluminum 、 PC
LED-TRSM8N	LED-TRSM8N-BK			4000K	715LM			
LED-TRSM8W	LED-TRSM8W-BK			3000K	715LM			

# 15W Tracklight

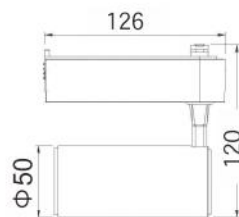

Item Code		Power	Voltage	CCT	Lumen	CRI	Beam Angle	Material
White	Black							
LED-TRCP15D	LED-TRCP15D-BK	15W	100 V   240V	6500K	1200LM	≥ 80, R9>0	36°	Aluminum 、 PC
LED-TRCP15N	LED-TRCP15N-BK			4000K	1200LM			
LED-TRCP15W	LED-TRCP15W-BK			3000K	1150LM			



# 7W Tracklight

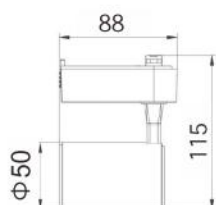

Item Code		Power	Voltage	CCT	Lumen	CRI	Beam Angle	Material
White	Black							
LED-TRCP7D	LED-TRCP7D-BK	7W	100 V   240V	6500K	500LM	≥ 80, R9>0	30°	Aluminum 、 PC
LED-TRCP7N	LED-TRCP7N-BK			4000K	500LM			
LED-TRCP7W	LED-TRCP7W-BK			3000K	450LM			

# 15W Tracklight

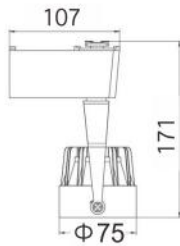

Item Code		Power	Voltage	CCT	Lumen	CRI	Beam Angle	Material
White	Black							
LED-TRAT15D	LED-TRAT15D-BK	15W	100 V   240V	6500K	1400LM	≥ 80, R9>0	20°	Aluminum , PC
LED-TRAT15W	LED-TRAT15W-BK			3000K	1300LM			

# 7W Tracklight

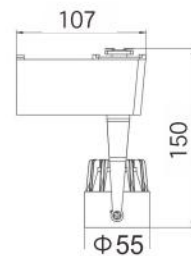

Item Code		Power	Voltage	CCT	Lumen	CRI	Beam Angle	Material
White	Black							
LED-TRAT7D	LED-TRAT7D-BK	7W	100 V   240V	6500K	600LM	≥ 80, R9>0	20°	Aluminum , PC
LED-TRAT7W	LED-TRAT7W-BK			3000K	560LM			



# 45W RA90 Ceiling Downlight

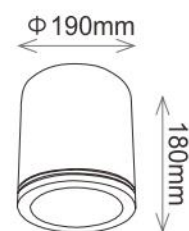

Item Code		Power	Voltage	CCT	Lumen	CRI	Beam Angle	Material
White	Black							
LED-CEB40DM	LED-CEB40DM-BK	40W	100 V   240V	3000~6500K	280-2800LM	≥ 80	35°	Die-casting Aluminum 、 Glass
LED-CEB45D	LED-CEB45D-BK	45W		5000K	3500LM	≥ 80		
LED-CEB45N	LED-CEB45N-BK			4000K	2800LM	≥ 90, R9>50		
LED-CEB45W	LED-CEB45W-BK			3000K	2800LM			

# 30W RA90 Ceiling Downlight



Item Code		Power	Voltage	CCT	Lumen	CRI	Beam Angle	Material
White	Black							
LED-CEB30DM	LED-CEB30DM-BK	30W	100 V   240V	3000~6500K	210-2100LM	≥ 80	35°	Die-casting Aluminum 、 Glass
LED-CEB30D	LED-CEB30D-BK			5000K	3500LM	≥ 80		
LED-CEB30N	LED-CEB30N-BK			4000K	2800LM	≥ 90, R9>50		
LED-CEB30W	LED-CEB30W-BK			3000K	2800LM			

# 12W RA90 Ceiling Downlight

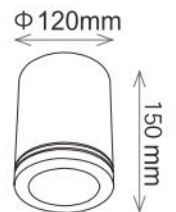
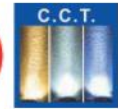

Item Code		Power	Voltage	CCT	Lumen	CRI	Beam Angle	Material
White	Black							
LED-CEB12D	LED-CEB12D-BK	12W	100 V   240V	6000K	800LM	$\geq 80$	45°	Die-casting Aluminum , Glass
LED-CEB12N	LED-CEB12N-BK			4000K	650LM	$\geq 90,$ R9>50		
LED-CEB12W	LED-CEB12W-BK			3000K	650LM			



# 24W RA90 Ceiling Downlight

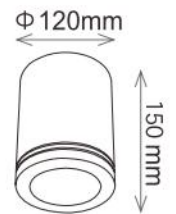

Item Code		Power	Voltage	CCT	Lumen	CRI	Beam Angle	Material
White	Black							
LED-CEB24D	LED-CEB24D-BK	24W	100 V   240V	6000K	1400LM	$\geq 80$	45°	Die-casting Aluminum 、 Glass
LED-CEB24N	LED-CEB24N-BK			4000K	1300LM	$\geq 90$ , R9>50		
LED-CEB24W	LED-CEB24W-BK			3000K	1300LM			

# Downlight Installation Guideline



1



2



3

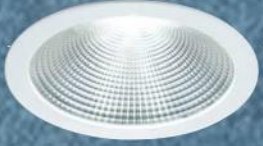

5



6



7



10



13



1 LED-24\"DOD45D  
245mm /4300LM/ 45W

2 LED-21\"DOD45D  
205mm /4300LM/ 45W

3 LED-25122D  
205mm /4400LM/ 45W

4 LED-25130D  
□ 245x125mm /3100LM/ 48W

5 LED-24\"DOD30D  
245mm / 2700LM/ 30W

6 LED-21\"DOD30D  
205mm /2700LM/ 30W

7 LED-25123D  
150mm /3000LM/ 30W

8 LED-25131W  
□ 245x125mm /1700LM/ 24W

9 LED-25128D  
□ 125mm /1500LM/ 24W

10 LED-15\"DOD24D  
155mm /1350LM/ 24W





- ⑪ LED-15"DOP16DR1  
150mm /1520LM/ 16W
- ⑫ LED-15"DOH16D  
150mm /1300LM/ 16W
- ⑬ LED-25132D  
90mm /900LM/ 12W
- ⑭ LED-15"DOP12DR1  
150mm /1140LM/ 12W
- ⑮ LED-9"DOD12W  
90mm /800LM/ 12W

- ⑯ LED-25129D  
□ 125mm /900LM/ 12W
- ⑰ LED-12"DOP12DR1  
120mm /1140LM/ 12W
- ⑱ LED-7"DOD9W  
70mm /450LM/ 9W

6M

5M

4M

3M

2M

1M



# 45W Anti-Glare Downlight

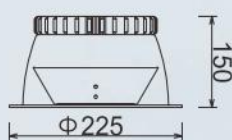
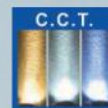

  $\Phi 205\text{mm}$



Item Code	Power	Voltage	CCT	Lumen	CRI	Beam Angle	Material
LED-25122D	45W	100 V   240V	5000K	4400LM	$\geq 80$	100°	Die-casting Aluminum
LED-25122N			4000K	4250LM			
LED-25122W			3000K	4250LM			

# 30W Anti-Glare Downlight

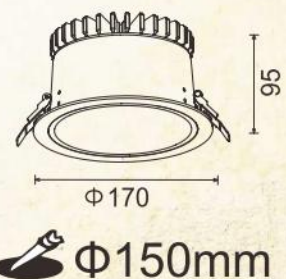
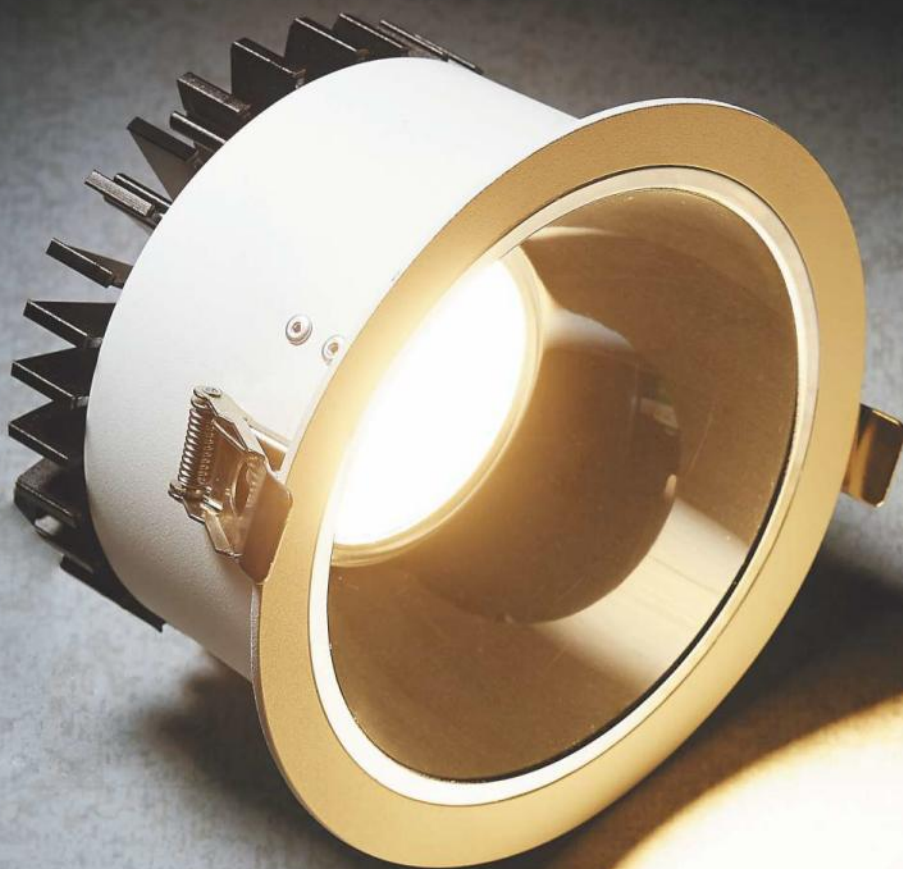

Item Code	Power	Voltage	CCT	Lumen	CRI	Beam Angle	Material
LED-25123D	30W	100 V   240V	5000K	3000LM	$\geq 80$	100°	Die-casting Aluminum
LED-25123N			4000K				
LED-25123W			3000K				



# 45W/30W High Ceiling Downlight

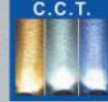

## 45W

Item Code	Power	Voltage	CCT	Lumen	CRI	Beam Angle	Material
LED-24"DOD40DM	40W	100 V   240V	3000K~6000K	370-3700LM	≥ 80	90°	Die-casting Aluminum 、 Glass
LED-24"DOD45D	45W		5000K	4300LM	≥ 80		
LED-24"DOD45N			4000K	3700LM	≥ 90, R9>50		
LED-24"DOD45W			3000K	3700LM			

## 30W

Item Code	Power	Voltage	CCT	Lumen	CRI	Beam Angle	Material
LED-24"DOD30DM	30W	100 V   240V	3000K~6500K	235-2350LM	≥ 80	90°	Die-casting Aluminum 、 Glass
LED-24"DOD30D			5000K	2700LM	≥ 80		
LED-24"DOD30N			4000K	2350LM	≥ 90, R9>50		
LED-24"DOD30W			3000K	2350LM			



# 45W/30W High Ceiling Downlight

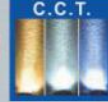

## 45W

Item Code	Power	Voltage	CCT	Lumen	CRI	Beam Angle	Material
LED-21"DOD40DM	40W	100 V   240V	3000K~6000K	370-3700LM	≥ 80	90°	Die-casting Aluminum 、 Glass
LED-21"DOD45D	45W		5000K	4300LM	≥ 80		
LED-21"DOD45N			4000K	3700LM	≥ 90, R9>50		
LED-21"DOD45W			3000K	3700LM			

## 30W

Item Code	Power	Voltage	CCT	Lumen	CRI	Beam Angle	Material
LED-21"DOD30DM	30W	100 V   240V	3000K~6500K	235-2350LM	≥ 80	90°	Die-casting Aluminum 、 Glass
LED-21"DOD30D			5000K	2700LM	≥ 80		
LED-21"DOD30N			4000K	2350LM	≥ 90, R9>50		
LED-21"DOD30W			3000K	2350LM			

# 30W Angle-adjustable Downlight



50 degrees



350 degrees



Item Code	Power	Voltage	CCT	Lumen	CRI	Beam Angle	Material
LED-25124DM	30W	100 V   240V	3000K~6500K	220-2200LM	≥ 80	45°	Die-casting Aluminum 、 Glass
LED-25124D			5000K	2600LM	≥ 80		
LED-25124N			4000K	2200LM	≥ 90, R9>50		
LED-25124W			3000K	2200LM			



# 30W High Ceiling Downlight



Item Code	Power	Voltage	CCT	Lumen	CRI	Beam Angle	Material
LED-15"DOD24D	24W	100 V   240V	6500K	1350LM	$\geq 80$	45°	Die-casting Aluminum 、 Glass
LED-15"DOD24N			4000K	1100LM	$\geq 90, R9>50$		
LED-15"DOD24W			3000K	1100LM			



# 12W Angle-adjustable Downlight



Item Code	Power	Voltage	CCT	Lumen	CRI	Beam Angle	Material
LED-25132D	12W	100 V   240V	6000K	900LM	$\geq 80$	35°	Die-casting Aluminum 、 Glass
LED-25132N			4000K	760LM	$\geq 90,$ R9>50		
LED-25132W			3000K	700LM			

# 12W Anti-Glare Downlight



Item Code	Power	Voltage	CCT	Lumen	CRI	Beam Angle	Material
LED-25101D	12W	100 V   240V	6000K	900LM	$\geq 80$	25°	Die-casting Aluminum 、 Glass
LED-25101N			4000K	700LM	$\geq 90,$ R9>50		
LED-25101W			3000K	700LM			



# 12W Downlight

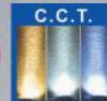

Item Code	Power	Voltage	CCT	Lumen	CRI	Beam Angle	Material
LED-9"DOD12D	12W	100V   240V	6500K	800LM	$\geq 80$	45°	Die-casting Aluminum 、 Glass
LED-9"DOD12N			4000K	650LM	$\geq 90,$ R9>50		
LED-9"DOD12W			3000K	650LM			



# 9W Downlight

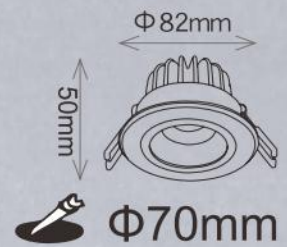

Item Code	Power	Voltage	CCT	Lumen	CRI	Beam Angle	Material
LED-7"DOD9D	9W	100V   240V	6500K	450LM	$\geq 80$	30°	Die-casting Aluminum 、 Glass
LED-7"DOD9N			4000K	400LM	$\geq 90,$ R9>50		
LED-7"DOD9W			3000K	400LM			

# 24W/48W Rectangle Downlight



 245x125mm



Item Code		Power	Voltage	CCT	Lumen	CRI	Beam Angle	Material
White	Black							
LED-25130D	LED-25130D-BK	48W	100 V   240V	6500K	3100LM	$\geq 80$	45°	Die-casting Aluminum 、 Glass
LED-25130N	LED-25130N-BK			4000K	2800LM	$\geq 90$ , R9>50		
LED-25130W	LED-25130W-BK			3000K	2800LM			
LED-25131D	LED-25131D-BK	24W		6500K	1700LM	$\geq 80$		
LED-25131N	LED-25131N-BK			4000K	1400LM	$\geq 90$ , R9>50		
LED-25131W	LED-25131W-BK			3000K	1400LM			

# 12W/24W Square Downlight



Item Code	Power	Voltage	CCT	Lumen	CRI	Beam Angle	Material
LED-25128D	24W	100 V   240V	6500K	1500LM	$\geq 80$	45°	Die-casting Aluminum 、 Glass
LED-25128N			4000K	1200LM	$\geq 90$ , R9>50		
LED-25128W			3000K	1200LM			
LED-25129D	12W		6500K	900LM	$\geq 80$		
LED-25129N			4000K	700LM	$\geq 90$ , R9>50		
LED-25129W			3000K	700LM			



# 12W High Efficiency Downlight

120  
LM/W

Safety-standard Passed Driver

Fast Connector

Integral Heat Sink

High-efficiency LED

High-transmittance Diffuser

Wide-area Al substrate

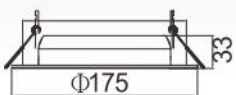
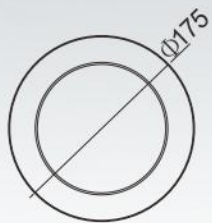

$\Phi 150\text{mm}$

Item Code	Power	Voltage	CCT	Lumen	CRI	Field Angle	Material
LED-15"DOP12DES	12W	100 V   240V	6500K	1440LM	$\geq 80$ , R9>0	160°	Thermally-Conductive Plastic 、 PC Diffuser
LED-15"DOP12WES			3000K				

# 16W/12W Downlight



LED-15"DOP16DR1

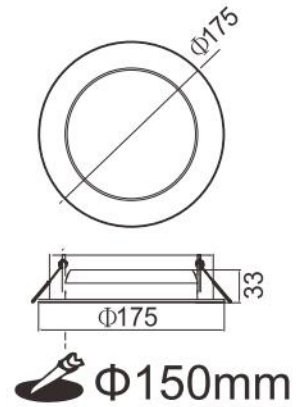

LED-12"DOP12DR1

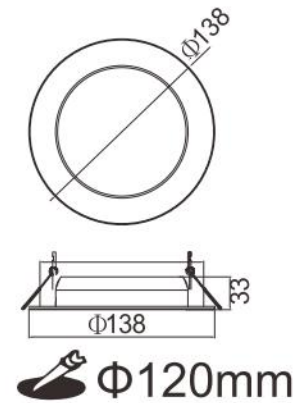

Item Code	Power	Voltage	CCT	Lumen	CRI	Field Angle	Material
LED-15"DOP16DR1	16W	100 V   240V	6500K	1520LM	≥ 80	160°	Thermally-Conductive Plastic 、 PC Diffuser
LED-15"DOP16NR1			4000K	1520LM			
LED-15"DOP16WR1			3000K	1440LM			
LED-15"DOP12DR1	12W		6500K	1140LM			
LED-15"DOP12NR1			4000K	1140LM			
LED-15"DOP12WR1			3000K	1080LM			
LED-12"DOP12DR1	12W		6500K	1140LM			
LED-12"DOP12NR1			4000K	1140LM			
LED-12"DOP12WR1			3000K	1080LM			

# Spot / Downlight

## 8W

LED-25090DR2



LED-25090DR2-BK



[adjustable angle 30°]

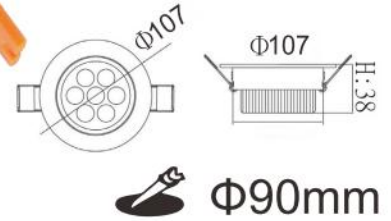

## 5W

LED-25097DR1



LED-25097DR1-BK



[adjustable angle 30°]

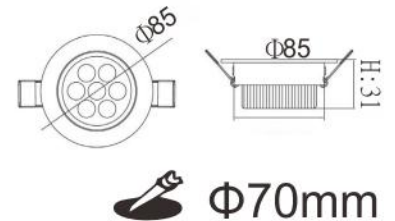

Item Code		Power	Voltage	CCT	Lumen	CRI	Beam Angle	Material
White	Black							
LED-25090DR2	LED-25090DR2-BK	8W	100V   240V	6000K	750LM	≥ 80	25°	Die-casting Aluminum 、 PC
LED-25090NR2	LED-25090NR2-BK			4000K	715LM			
LED-25090WR2	LED-25090WR2-BK			3000K	715LM			
LED-25097DR1	LED-25097DR1-BK	5W		6000K	415LM		18°	
LED-25097NR1	LED-25097NR1-BK			4000K	385LM			
LED-25097WR1	LED-25097WR1-BK			3000K	385LM			



# LED Ceiling-Mounted Light



LED-21030



LED-21031



LED-21032

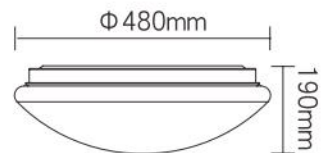

Item Code	Power	Voltage	CCT	Lumen	CRI	Material
LED-21030	30W	100V-240V	3000K	3000LM	$\geq 80$	Zinc Alloy 、 Glass
LED-21031						
LED-21032						

# Dimmable Ceiling-mounted Light

Control Distance  
20m

2.4GHZ RF  
Remote Controller

Wall Switch  
Quick Dimming

Memory  
Function

30 stages  
Colour Dimming



Dimmable



Remote control interface

# Dimmable Ceiling-mounted Light



Item Code	Power	Voltage	CCT	Lumen	CRI	Material	4-Stage Control IC
LED-CES75DMR1	75W	100V   240V	3000K   6500K	100~6500LM	≥ 80	PMMA Starry Cover 、 Iron Plate	Cool Light → Warm Light →4000K →Night Light

\*controlled by wall switch



# Dimmable Ceiling-mounted Light



LED-CES50DMR1

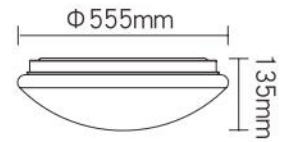

LED-CES30DMR1

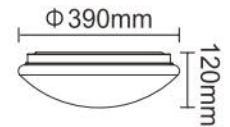

Item Code	Power	Voltage	CCT	Lumen	CRI	Material	4-Stage Control IC
LED-CES50DMR1	50W	100V-240V	3000K	100~5200LM	≥ 80	PMMA Starry Cover 、 Iron Plate	Cool Light → Warm Light → 4000 K → Night Light
LED-CES30DMR1	30W		6500K	100~2900LM			

\*controlled by wall switch

# LED Glass Ceiling-mounted Light



Item Code	Finish	Power	Voltage	CCT	Lumen	CRI	Field Angle	Material
LED-CEK16D-WH	White	16W	100V-240V	White	1250LM	≥ 80	130°	Iron Glass
LED-CEK16W-WH				Warm	1200LM			
LED-CEK16D-S	Silver			White	1250LM			
LED-CEK16W-S				Warm	1200LM			
LED-CEK16D-CW	Wood			White	1250LM			
LED-CEK16W-CW				Warm	1200LM			

# LED Ceiling-mounted Light



Item Code	Power	Voltage	CCT	Lumen	CRI	Field Angle	Material
LED-CED12DR2 LED-CED12WR2	12W	100V-240V	White Warm	900LM 800LM	≥ 80	160°	PMMA Cover 、 Iron Plate 、 PC Safety Cover
LED-CED16DR2 LED-CED16WR2	16W		White Warm	1150LM 1050LM			
LED-CED30DR1 LED-CED30WR1	30W		White Warm	2850LM 2650LM			



# LED Ceiling-mounted Light

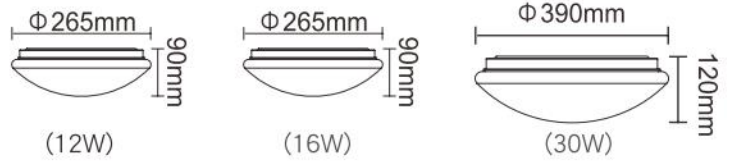

Item Code	Power	Voltage	CCT	Lumen	CRI	Field Angle	Material
LED-CES12DR2	12W	100V-240V	White	900LM	$\geq 80$	160°	PMMA Cover 、 Iron Plate 、 PC Safety Cover
LED-CES12WR2			Warm	800LM			
LED-CES16DR2	16W		White	1150LM			
LED-CES16WR2			Warm	1050LM			
LED-CES30DR1	30W		White	2800LM			
LED-CES30WR1			Warm	2700LM			

# LED Ceiling-mounted Light

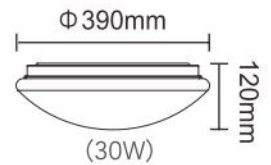
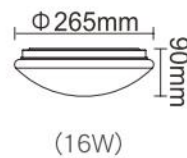
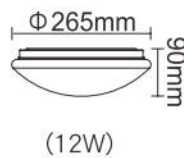

Item Code	Power	Voltage	CCT	Lumen	CRI	Field Angle	Material
LED-CE12DR2	12W	100V-240V	White	950LM	≥ 80	160°	PMMA Cover 、 Iron Plate 、 PC Safety Cover
LED-CE12WR2			Warm	850LM			
LED-CE16DR2	16W		White	1200LM			
LED-CE16WR2			Warm	1100LM			
LED-CE30DR1	30W		White	2900LM			
LED-CE30WR1			Warm	2800LM			

# Microwave Ceiling Sensor Light



Item Code	Power	Voltage	CCT	Lumen	CRI	Field Angle	Material	IP
OD-CE16DSE	16W	100V-240V	6250K	1400LM	≥ 80	140°	PC	IP66
OD-CE16WSE			3000K	1300LM				



# LED Ceiling-mounted Light

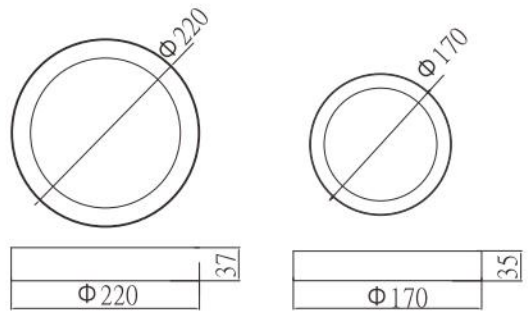

Item Code	Power	Voltage	CCT	Lumen	CRI	Field Angle	Material
LED-21029D	18W	100V-240V	6000K	1600LM	≥ 80	160°	Aluminum
LED-21029W			3000K	1540LM			
LED-21028D	12W		6000K	1040LM			
LED-21028W			3000K	990LM			

# LED Pendant Lamp

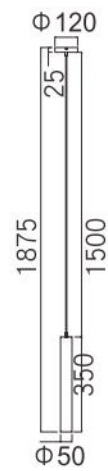
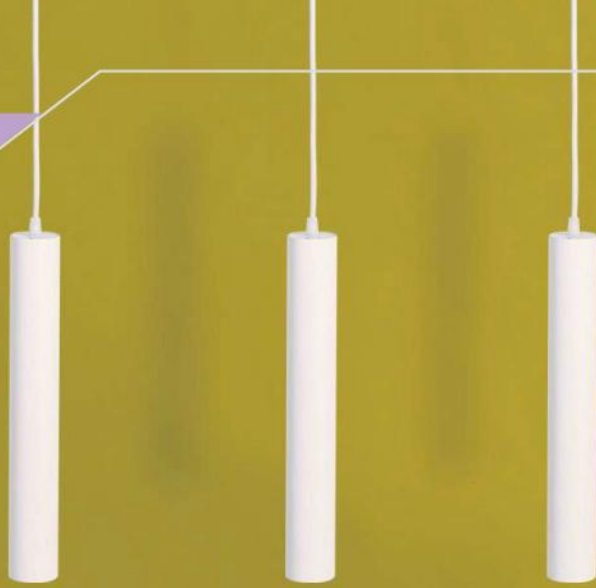

Item Code	Finish	Power	Voltage	CCT	Lumen	CRI	Field Angle	Material
LED-29014	Black	12W	100V-240V	3000K	650LM	≧ 90	36°	Aluminum Plastic
LED-29015	White							

# LED Pendant Lamp

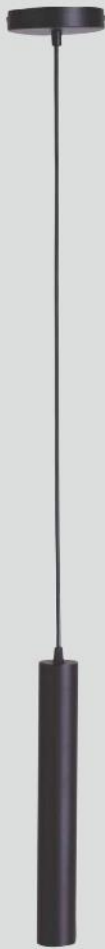

Item Code	Finish	Power	Voltage	CCT	Lumen	CRI	Field Angle	Material
LED-29016	Black	20W	100V-240V	3000K	1400LM	$\geq 90$	36°	Aluminum Plastic
LED-29017	White							





# Bedside Wall Light



Two Lighting Modes

90° Adjustable Angle

Two Control Switches

Simple Classic Design

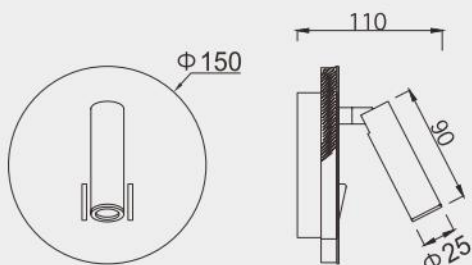

Item Code	Power	Voltage	CCT	Lumen	CRI	Material
LED-26011	8W	100V-240V	3000K	487LM	≥ 80	Aluminum 、 Iron

# Bedside Wall Light

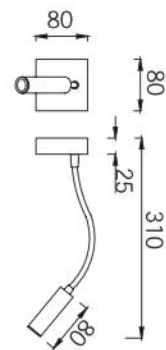

Item Code	Power	Voltage	CCT	Lumen	CRI	Material
LED-26010-BK	3W	100V-240V	3000K	170LM	$\geq 80$	Aluminum 、 Iron



# Bedside Wall Light



Item Code	Finish	Power	Voltage	CCT	Lumen	CRI	Material
LED-26009	Black	3W	100V-240V	3000K	135LM	$\geq 80$	Aluminum 、 Iron
LED-26009-BK	White						



# LED Wall Light



Item Code	Power	Voltage	CCT	Lumen	CRI	Material
LED-26001-BK	7W	100V-240V	3000K	350LM	≥ 80	Die-casting Aluminum 、 Acrylic



# LED Wall Light

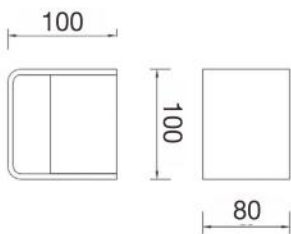

Item Code	Power	Voltage	CCT	Lumen	CRI	Material
LED-26002-BK	7W	100V-240V	3000K	250LM	≥ 80	Die-casting Aluminum 、 Acrylic



# LED Wall Light

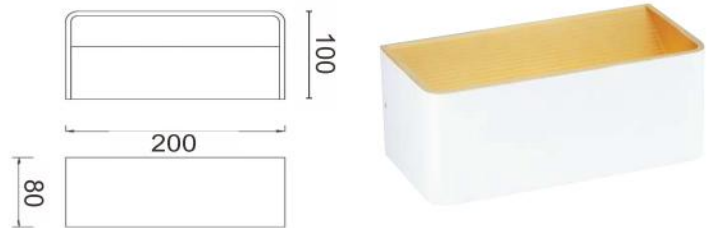

Item Code	Power	Voltage	CCT	Lumen	CRI	Material
LED-26001	7W	100V-240V	3000K	350LM	≥ 80	Die-casting Aluminum 、 Acrylic

# LED Wall Light

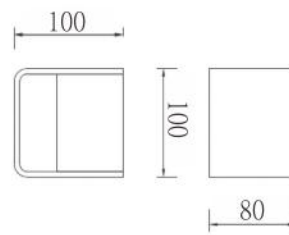

Item Code	Power	Voltage	CCT	Lumen	CRI	Material
LED-26002	7W	100V-240V	3000K	250LM	$\geq 80$	Die-casting Aluminum 、 Acrylic

# LED Wall Light

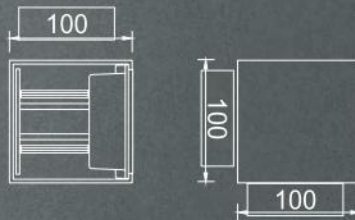

Item Code	Power	Voltage	CCT	Lumen	CRI	Material
LED-26007	7W	100V-240V	3000K	380LM	$\geq 80$	Die-casting Aluminum 、 Glass



# LED Wall Light



Item Code	Power	Voltage	CCT	Lumen	CRI	Material
LED-26005	7W	100V-240V	3000K	490LM	≥ 80	Die-casting Aluminum 、 Glass
LED-26008				480LM		

# Giraffe LED Desk Lamp



Yellow



Pink

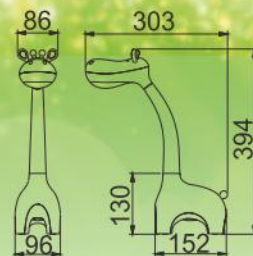

LIGHT SETTING



RIGHT  
ON/OFF

Main Light ON(One Touch) / OFF (Long Press)

Color Temperature adjusting (Day Light > 4000K > Warm Light)



LEFT  
DIM

Three-Stage Dimming : High > Medium > Low

LED Bottom Light ON(Long press) / OFF (Long press)



Night Light Mode



Bendable Design

Item Code	Body Color	Power	Voltage	CCT	Lumen	CRI	Material
LED-DLGF6-P	PINK	6W	100V-240V	3000K	350LM (MAX) 、 Night Light	≥ 80	ABS
LED-DLGF6-Y	YELLOW			4800K 6000K			



# Modern LED Desk Lamp



White



Black



YouTube Clip



Dimming by Touch Bar



ON/OFF



Color Temperature adjusting  
(Day Light > 4000K > Warm Light)



2 Stages Night Light

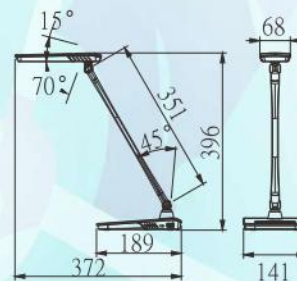

Item Code	Body Color	Power	Voltage	CCT	Lumen	CRI	Field Angle	Material
LED-DLUR8	White	8W	100V-240V	3000K	420LM (MAX) Night Light	≥ 80	120°	ABS
LED-DLUR8-BK	Black			4800K 6000K				



# 12W Dimmable Bulb

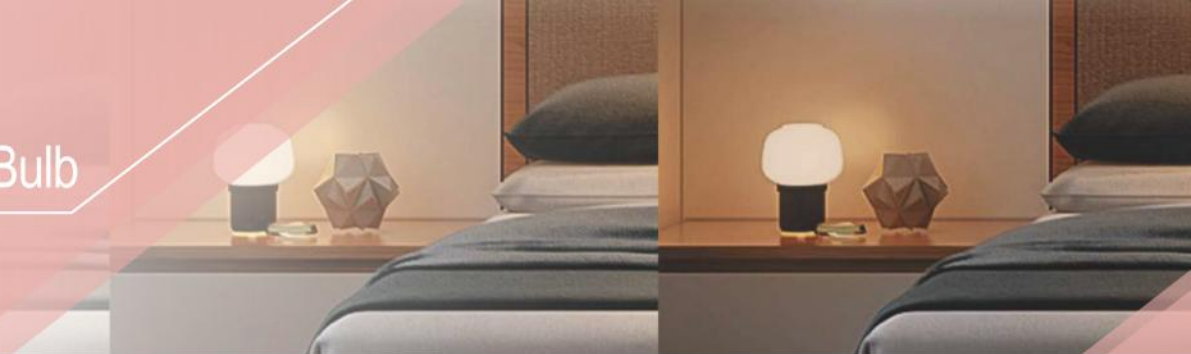

Suitable Dimmer

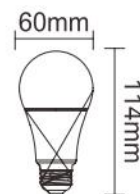

YouTube Clip

Item Code	Power	Voltage	CCT	Lumen	CRI	Field Angle	Material
LED-E2712WDM	12W	100V   240V	3000K	100LM~ 1150LM	≥ 80	320°	Thermally-Conductive Plastic 、 PC Diffuser

# LED E27 Bulb



7W



10W



12W



16W

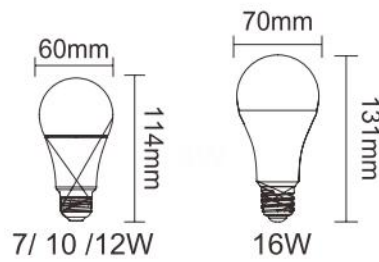

Item Code	Power	Voltage	CCT	Lumen	CRI	Field Angle	Material
LED-E277DR5	7W	100V~240V	6500K	600LM	≥ 80	340°	Thermally-Conductive Plastic & Aluminum 、 PC Diffuser
LED-E277WR5			3000K	570LM			
LED-E2710DR5	10W		6500K	950LM			
LED-E2710NR5			4000K	950LM			
LED-E2710WR5			3000K	900LM			
LED-E2712DR5	12W		6500K	1200LM			
LED-E2712NR5			4000K	1200LM			
LED-E2712WR5			3000K	1150LM			
LED-E2716DR5	16W		6500K	1650LM			
LED-E2716NR5			4000K	1650LM			
LED-E2716WR5			3000K	1550LM			

# LED High Power Bulb



E40 80W



E40 50W



E27 50W

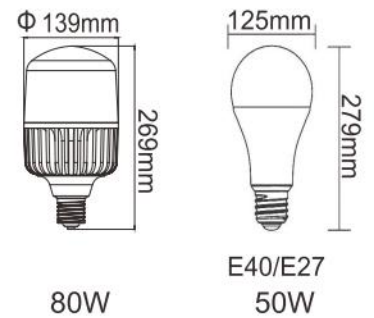

80W

E40/E27  
50W

Item Code		Power	Voltage	CCT	Lumen	CRI	Field Angle	Material
LED-E4080D	E40	80W	100V~240V	6500K	8800LM	≥ 80	310°	Die-casting Aluminum PC Diffuser
LED-E4050D	E40	50W			4800LM			Thermally-Conductive Plastic & Aluminum PC Diffuser
LED-E2750D	E27				5500LM			





38W



25W



PAR38 14W

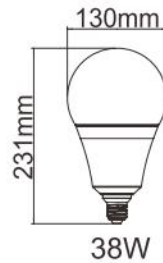

38W

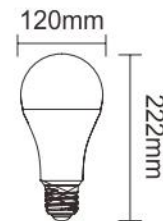

25W



PAR38 14W

Item Code	Power	Voltage	CCT	Lumen	CRI	Field Angle	Material
LED-E2738DR1	38W	100V   240V	6500K	4000LM	≥ 80	300°	Thermally-Conductive Plastic & Aluminum 、 PC Diffuser
LED-E2738WR1			3000K	4000LM			
LED-E2725DR1	25W		6500K	2625LM		300°	
LED-E2725WR1			3000K	2625LM			
LED-PAR3814W	14W		3000K	1050LM		33°	

# 12W Mosquito Bulb

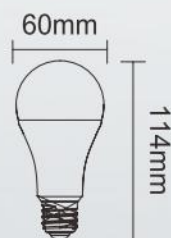
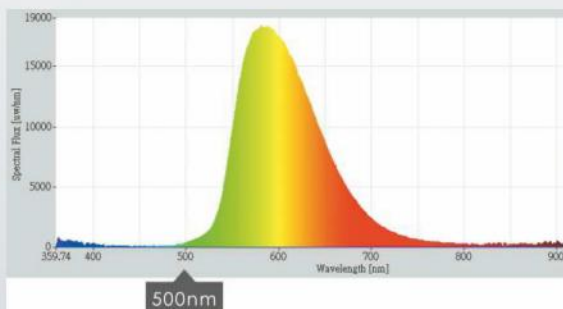

Item Code	Power	Voltage	CCT	Lumen	Field Angle	Material
LED-E2712Y	12W	100V-240V	2200K (500~750nm)	680LM	330°	Thermally-Conductive Plastic

# LED 3W E27 BULB



LED-E273WR1



LED-E273DR1



LED-E273RR1



LED-E273BR1



LED-E273GR1

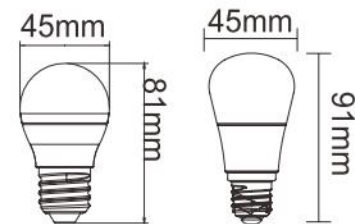

Colour Bulb E273DR1



YouTube Clip

Item Code	Power	Voltage	CCT	Lumen	CRI	Field Angle	Material
LED-E273WR1	3W	100V   240V	3000K	230	≥ 80	340°	Thermally-Conductive Plastic & Aluminum 、 PC Diffuser
LED-E273DR1			6500K	260			
LED-E273RR1			620nm (RED)	-	--		
LED-E273BR1			460nm (BLUE)	-			
LED-E273GR1			540nm (GREEN)	-			



# LED Candle Light

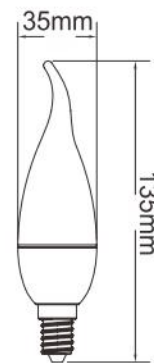

LED-E144WC/TA

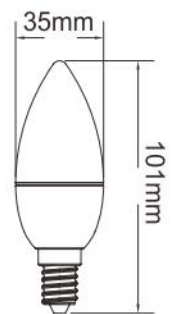

LED-E144WC

Item Code		Power	Voltage	CCT	Lumen	CRI	Field Angle	Material
LED-E144WC	E14	4W	100 V   240V	3000K	360LM	≥ 80	200°	Thermally-Conductive Plastic & Aluminum PC Diffuser
LED-E144WC/TA	E14							

# LED Filament Light

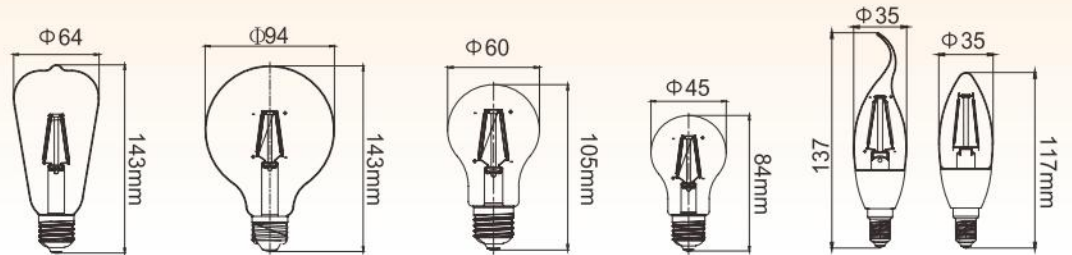

Item Code		Power	Voltage	CCT	Lumen	CRI	Field Angle	Material
LED-E27ED6YSTR1	E27	6.5W	100 V~ 240V	2200K	690LM	≥ 80	285°	Glass
LED-E27ED6G95R1	E27			2700K	810LM			
LED-E27ED6CR1	E27			2700K	810LM			
LED-E27ED4CR1	E27	4W		2700K	470LM			
LED-E14ED4TAR1	E14							
LED-E14ED4WCR1	E14							

# AC AR111 Spotlight Bulb

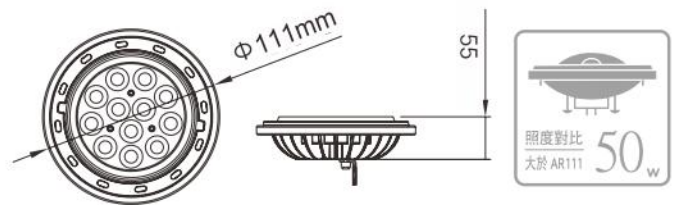

Item Code	Power	Voltage	CCT	Lumen	CRI	Field Angle	Material
LED-AR9DR2	9W (internal driver)	100 V   240V	5700K	950	≥ 80	24°	Thermally-Conductive Plastic 、 Aluminum
LED-AR9WR2			2700K	900			



# AR111 Spotlight Bulb

LED-AR14DR1



external driver



LED-AR14DR1-BK



external driver

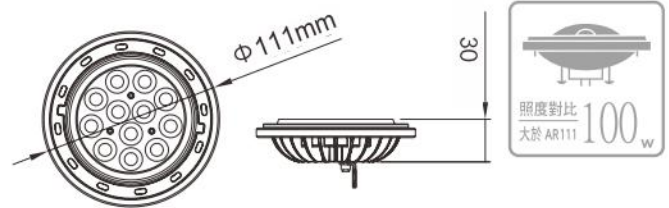

Item Code		Power	Voltage	CCT	Lumen	CRI	Beam Angle	Material
White	Black							
LED-AR14DR1	LED-AR14DR1-BK	14W	100 V   240V	5700K	1250LM	≥ 80	24°	Aluminum
LED-AR14NR1	LED-AR14NR1-BK			4000K	1250LM			
LED-AR14WR1	LED-AR14WR1-BK			2700K	1150LM			

# AC MR16 Spotlight Bulb

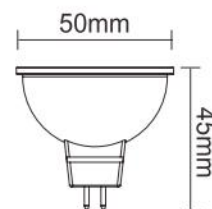

Item Code	Power	Voltage	CCT	Lumen	CRI	Beam Angle	Material
LED-MR166W-NP	100 V   240V (internal driver)	6W	3000K	520LM	$\geq 80$	36°	Thermally-Conductive Plastic & Aluminum PC Diffuser

# MR16 Spotlight

LED-MR166WR3



LED-MR168WR2



external driver

external driver

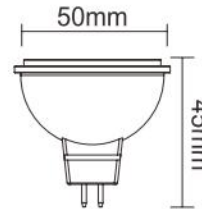

LED-MR166WR3

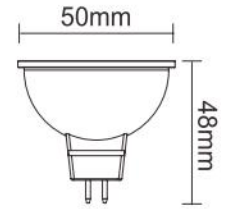

LED-MR168WR2

Item Code	Power	Voltage	CCT	Lumen	CRI	Beam Angle	Material
LED-MR166DR3	6W (with driver)	DC12V	6500K	400LM	$\geq 80$	36°	Thermally-Conductive Plastic & Aluminum、PC Diffuser
LED-MR166NR3			4000K				
LED-MR166WR3			3000K				
LED-MR168WR2	8W (with driver)		3000K	550LM			



# Microwave Sensor LED Tube

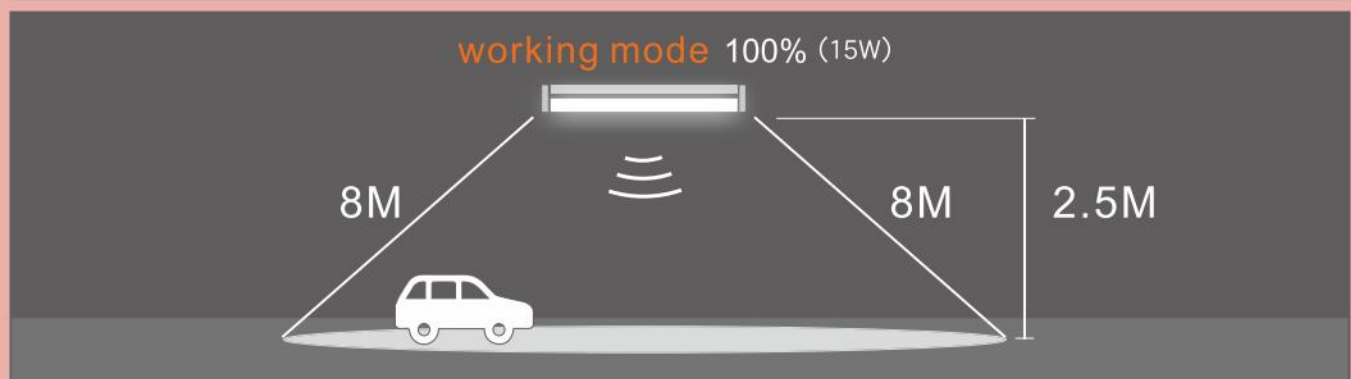
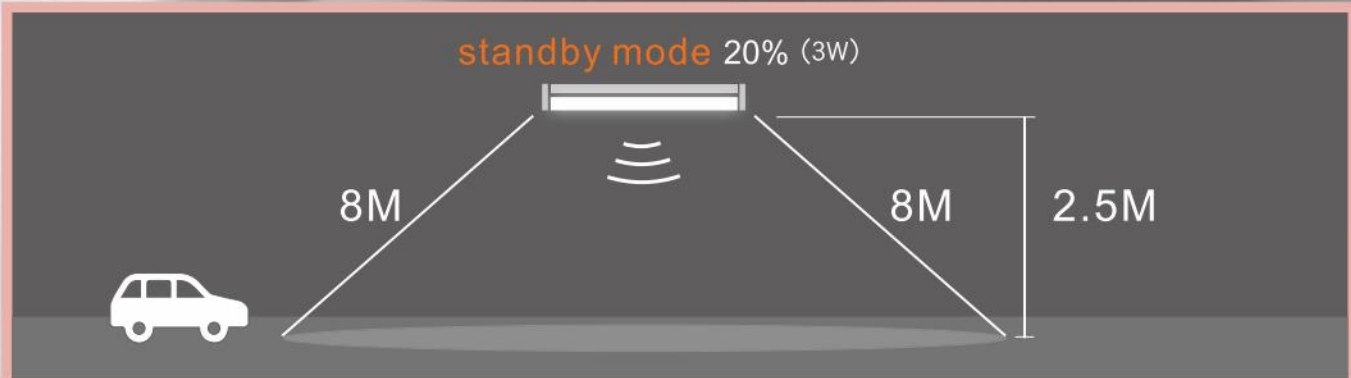

# Microwave Sensor LED Tube

140  
LM/W

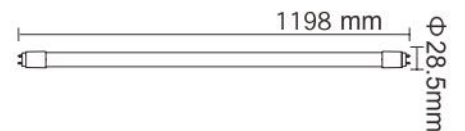

Item Code	Power	CCT	Lumen	CRI	Field Angle	Material
LED-T815DGL-MS	stand-by 3W working 15W	6500K	2100LM	≥ 80	300°	Heat resistant tube cap、 Glass、Aluminum Substrate

# LED T8 Tube

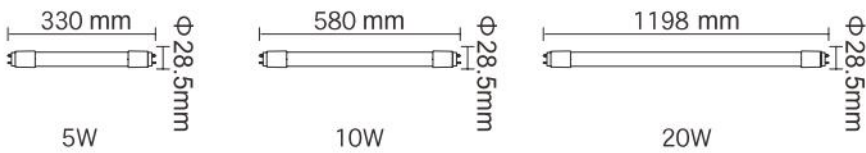
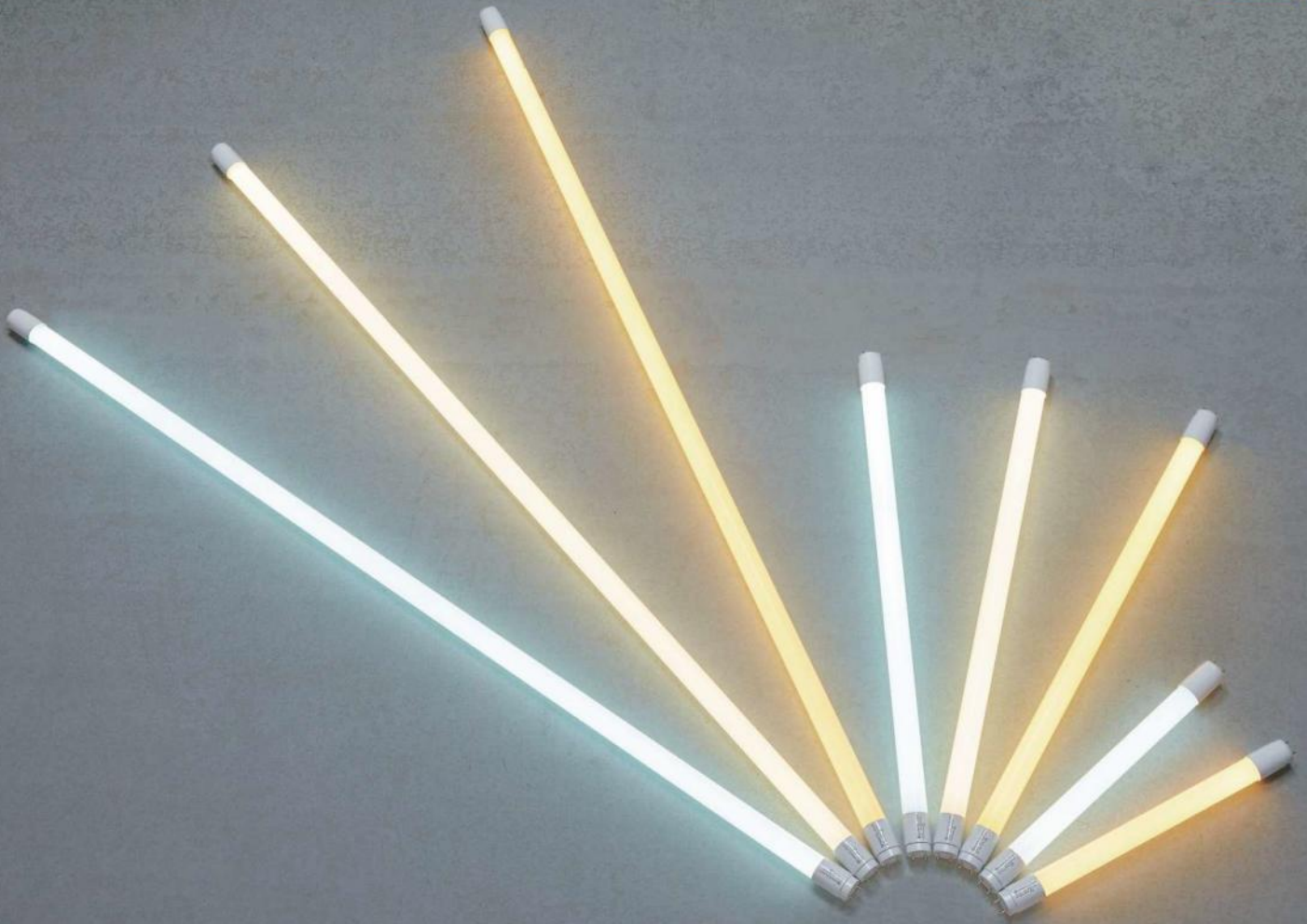

Item Code	Power	CCT	Lumen	CRI	Field Angle	Material
LED-T820DGLR3	20W	6500K	2200LM	$\geq 80$	300°	Heat resistant tube cap 、 Aluminum Substrate 、 Glass
LED-T820NGLR3		4000K	2200LM			
LED-T820WGLR3		3000K	2000LM			
LED-T810DGLR3	10W	6500K	1100LM			
LED-T810NGLR3		4000K	1100LM			
LED-T810WGLR3		3000K	1000LM			
LED-T85DGLR3	5W	6500K	525LM			
LED-T85WGLR3		3000K	500LM			



# LED Wall Light

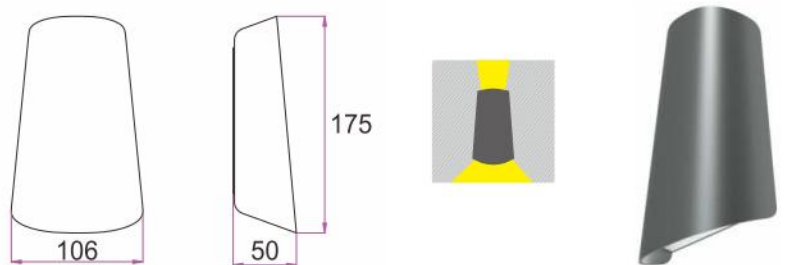

Item Code	Power	Voltage	Driver	CCT	Lumen	CRI	Material
OD-2297	11W	100V-240V	Water-proof Type	3000K	360LM	≥ 80	Die-casting Aluminum

# LED Wall Light

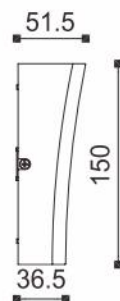

Item Code	Power	Voltage	Driver	CCT	Lumen	CRI	Material
OD-2298	6W	100V-240V	Water-proof Type	3000K	340LM	≥ 80	Die-casting Aluminum



# LED Wall Light

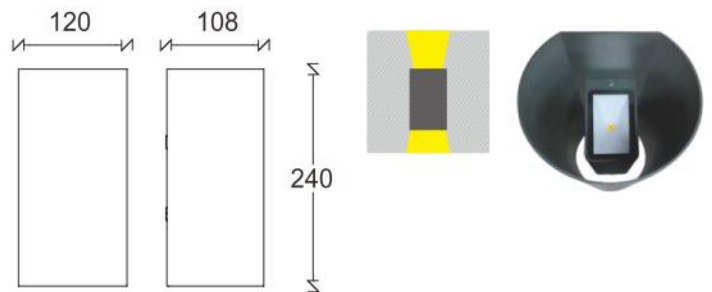

Item Code	Power	Voltage	Driver	CCT	Lumen	CRI	Material
OD-2299	14W	100V-240V	Water-proof Type	3000K	725LM	≥ 80	Die-casting Aluminum 、 Tempered Glass



# LED Wall Light

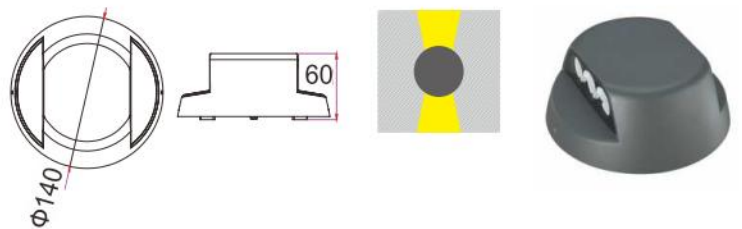

Item Code	Power	Voltage	Driver	CCT	Lumen	CRI	Material
OD-2249	8W	100V-240V	Water-proof Type	3000K	400LM	≥ 80	Die-casting Aluminum 、 Tempered Glass



# LED Wall Light



OD-2272



OD-2273

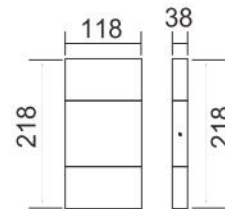
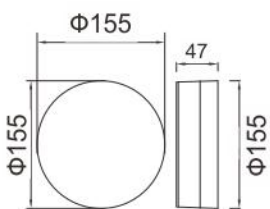

Item Code	Power	Voltage	Driver	CCT	Lumen	CRI	Material
OD-2272	10W	100V-240V	Water-proof Type	3000K	500LM	≧ 80	Die-casting Aluminum、PC
OD-2273					480LM		

# LED Wall Light

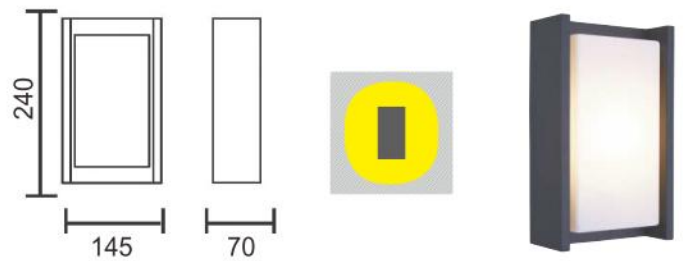

Item Code	Power	Voltage	Driver	CCT	Lumen	CRI	Material
OD-2263	8W	100V-240V	Water-proof Type	3000K	210LM	≥ 80	Die-casting Aluminum 、 PC



# Outdoor Garden Lamp

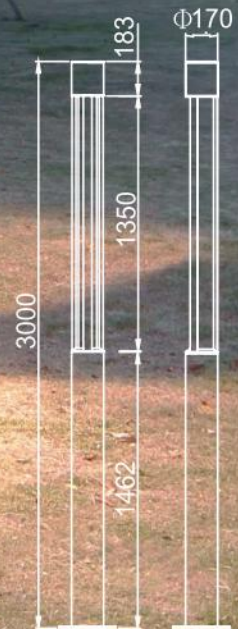

Item Code	Power	Voltage	Driver	CCT	Lumen	CRI	Material
OD-1501	30W	89V-265V	Water-proof MeanWell Driver	3000K	2000LM	≥ 80	Die-casting Aluminum 、 Tempered Glass



# LED Lawn Light

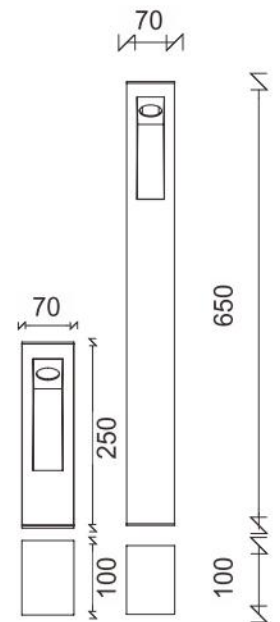

Item Code	Power	Voltage	Driver	CCT	Lumen	CRI	Material
OD-3181-25	8W	100V-240V	Water-proof Type	3000K	89LM	≥ 80	Die-casting Aluminum 、 Tempered Glass
OD-3181-65							

# LED Lawn Light

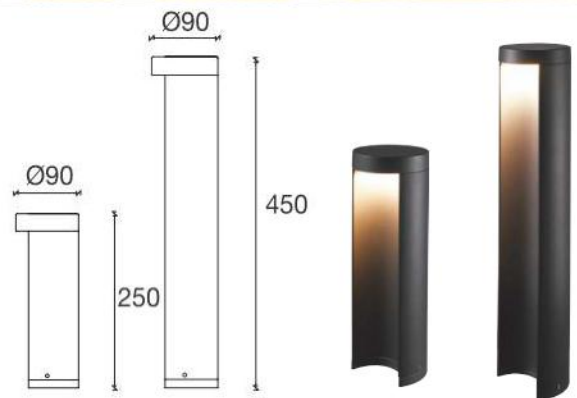

Item Code	Power	Voltage	Driver	CCT	Lumen	CRI	Material
OD-3182-25	8W	100V-240V	Water-proof Type	3000K	480LM	≥ 80	Die-casting Aluminum 、 Tempered Glass
OD-3182-45							



# LED Lawn Light

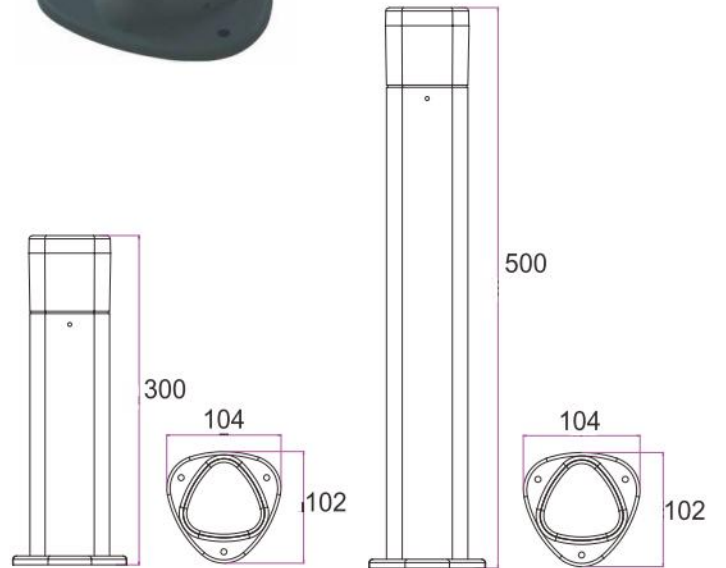

Item Code	Power	Voltage	Driver	CCT	Lumen	CRI	Material
OD-3179-30	7W	100V-240V	Water-proof Type	3000K	400LM	≥ 80	Die-casting Aluminum 、 PC
OD-3179-50							



# LED Lawn Light





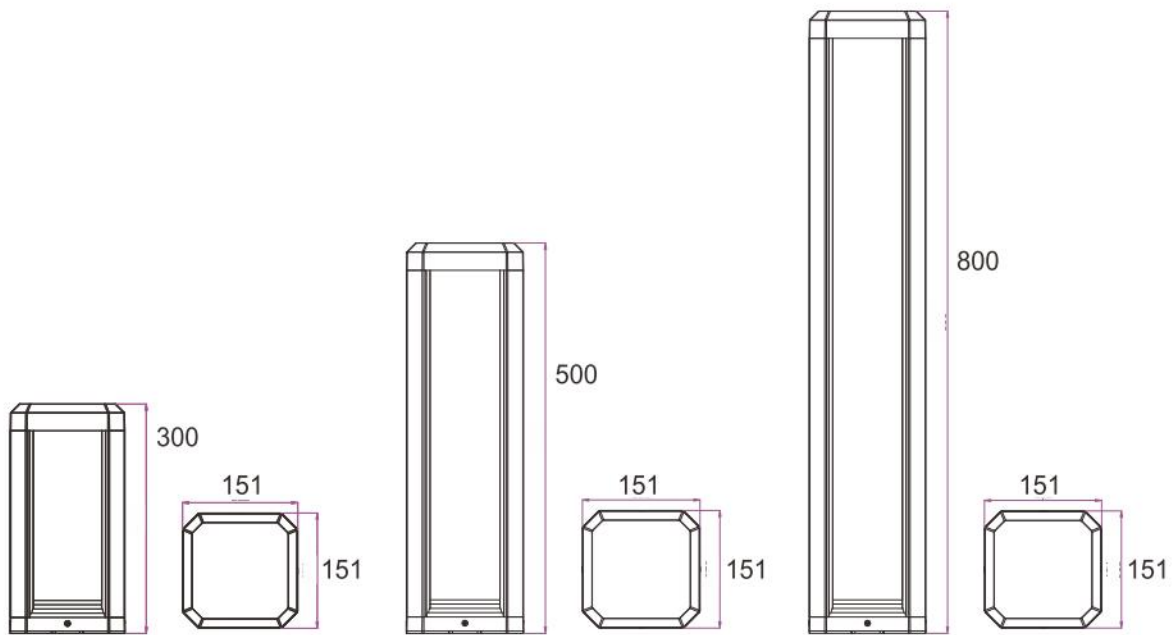

Item Code	Power	Voltage	Driver	CCT	Lumen	CRI	Material
OD-3180-30	13W	100V-240V	Water-proof Type	3000K	250LM	≥ 80	Die-casting Aluminum
OD-3180-50							
OD-3180-80							



# LED Lawn Light

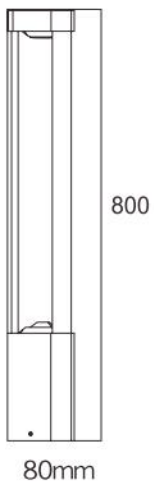
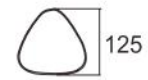
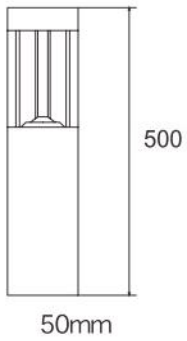
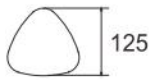
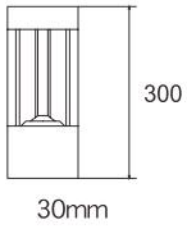





Item Code	Height	Power	Voltage	Driver	CCT	Lumen	CRI	Material
OD-3159R2	30cm	10W	100V-240V	Water-proof Type	3000K	340LM	$\geq 80$	Die-casting Aluminum 、 PC
OD-3150R2	50cm							
OD-3168R2	80cm							



# LED Garden Spotlight

IP66



(7 meters height)  
OD-3177SP

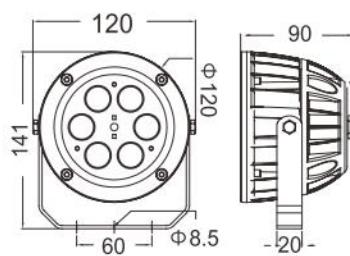

Item Code	Power	Voltage	CCT	Lumen	CRI	Beam Angle	Material
OD-3177SP	18W	100V-240V	3000K	1450LM	≥ 80	15°	Die-casting Aluminum Tempered Glass



# LED Garden Spotlight



(3.5 meters height)  
OD-3177

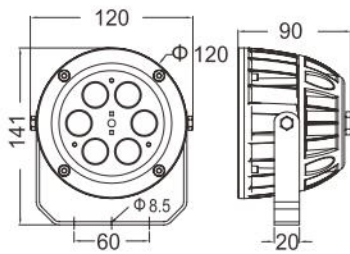

Item Code	Power	Voltage	CCT	Lumen	CRI	Beam Angle	Material	Installation
OD-3177	18W	100V-240V	3000K	1450LM	≥ 80	35°	Die-casting Aluminum	Surface type
OD-3174	9W			700LM		30°	Tempered Glass	Plug-in type (in-ground stand is not included)



# LED Garden Spotlight

IP66



OD-3162 (8W)



OD-3175R1 (5W)

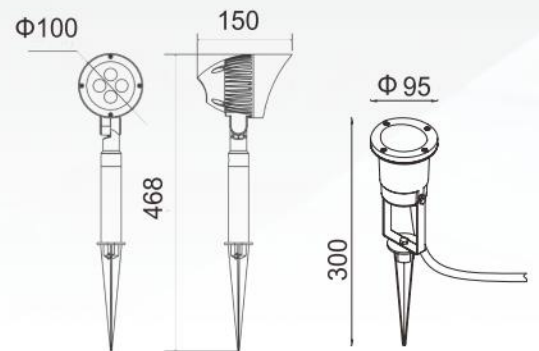

Item Code	Power	Voltage	Driver	CCT	Lumen	CRI	Beam Angle	Material
OD-3162	8W	100V-240V	Water-proof Type	3000K	500LM	$\geq 80$	30°	Die-casting Aluminum
OD-3175R1	5W				350LM	$\geq 75$	45°	Die-casting Aluminum Tempered Glass

# LED Garden Spotlight



LED-10009-FT



LED-10011-FT

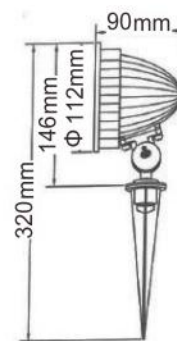
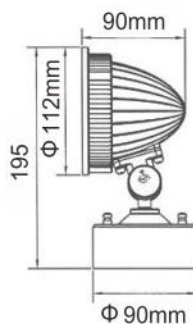

Item Code	Power	Voltage	Driver	CCT	Lumen	CRI	Beam Angle	Material
LED-10009-FT (Surface type)	9W	100V-240V	Water-proof Type	3000K	600LM	≥ 75	15°	Die-casting Aluminum 、 Tempered Glass
LED-10011-FT (Plug-in type)								



# Anti-glare Step Light

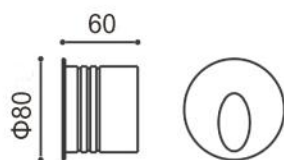

Item Code	Power	Voltage	Driver	CCT	Lumen	CRI	Material	Installation
OD-4137	3W	100   240V	Water-proof Type	3000K	340LM	≥ 80	Die-casting Aluminum	Φ77mmx70mm

# Anti-glare Step Light



YouTube Clip

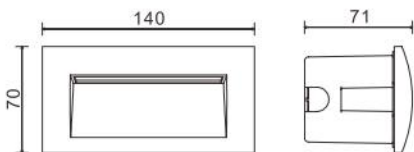

Item Code	Power	Voltage	Driver	CCT	Lumen	CRI	Material	Installation
OD-4136W	3W	100   240V	Water-proof Type	3000K	90LM	$\geq 80$	Die-casting Aluminum	L: 115mm W: 55mm D: 60mm
OD-4136W-BK								



# Anti-glare Step Light

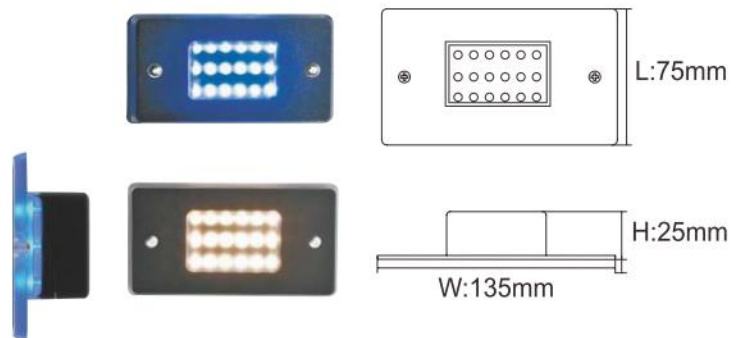

Item Code	Power	Voltage	Driver	CCT	Lumen	Material	Installation
OD-4132	1.6W	110-240V	Water-proof Type	Blue	-	304 stainless steel , PC	L:60mm W:40mm H:19mm
OD-4133				3000K	90LM		



# LED Underground Light

IP66



Item Code	Power	Voltage	Driver	CCT	Lumen	CRI	Beam Angle	Material
OD-4135W	4W	110-240V	Water-proof Type	3000K	250LM	≥ 80	45°	stainless steel 、 glass 、 embedded box
OD-4123WR3	1.2W			3000K	65LM			
OD-4123BR3				Blue	-			



# LED Flood Light

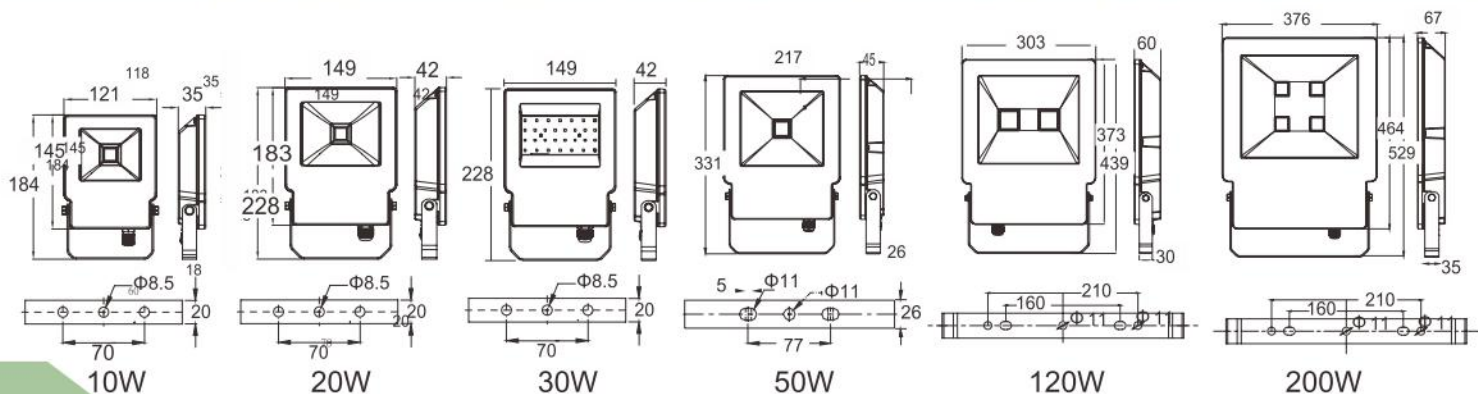
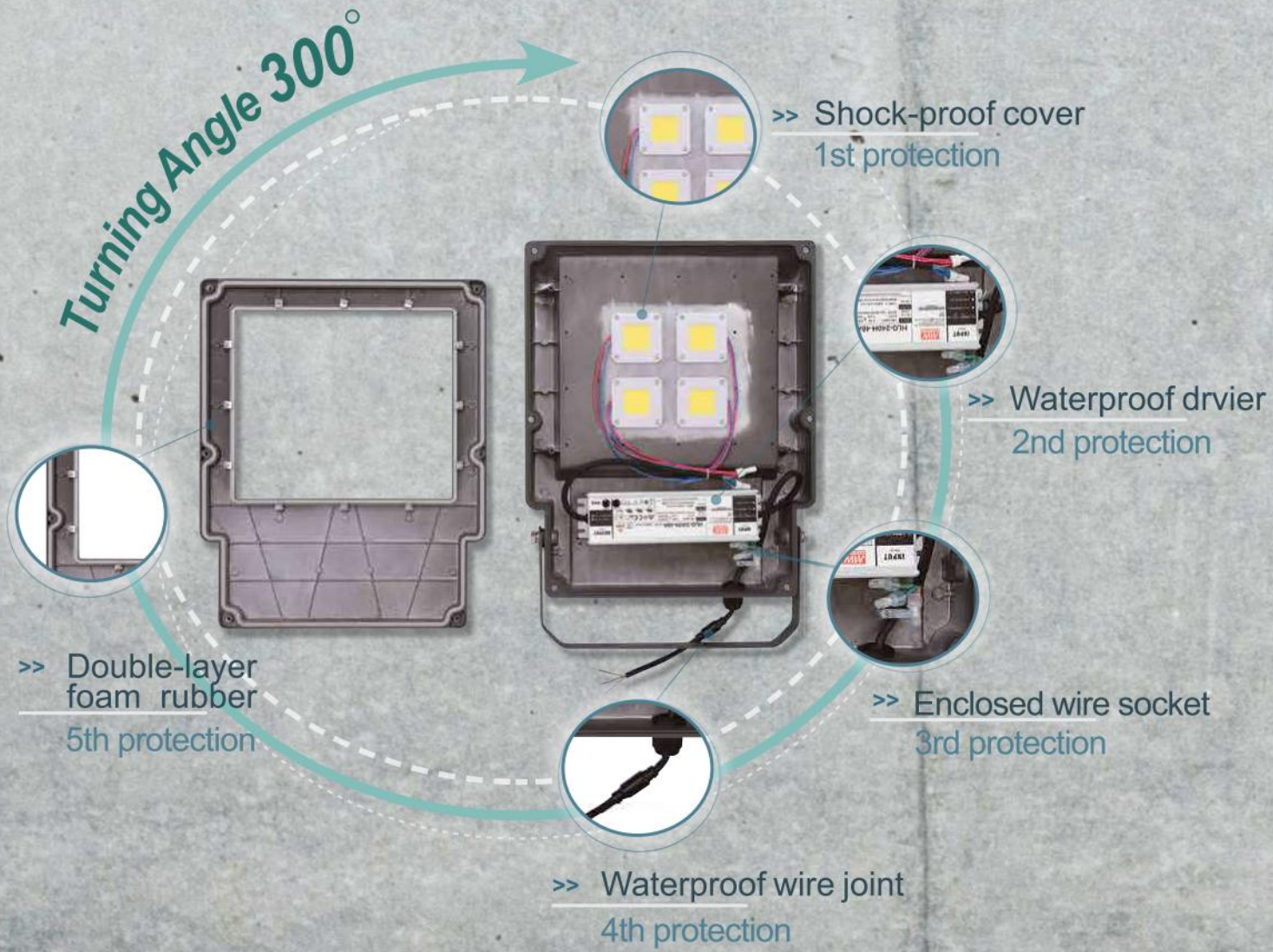

# LED Flood Light



10W

20W

30W

50W



120W

200W



YouTube Clip

Item Code	Power	Voltage	CCT	Lumen	CRI	Field Angle	Material
OD-FL10D	10W	100V-240V	6000K	750LM	≥ 70	140°	Die-casting Aluminum 、 Tempered Glass
OD-FL10W			3000K	680LM			
OD-FL20D	20W		6000K	1600LM			
OD-FL20W			3000K	1430LM			
OD-FL30D	30W		6000K	2500LM			
OD-FL30W			3000K	2200LM			
OD-FL50D	50W		6000K	4600LM			
OD-FL50W			3000K	4100LM			
OD-FL120DR2	120W	100V-277V	6000K	11800LM			
OD-FL120WR2			3000K	9900LM			
OD-FL200DR2/2	200W	180V-277V	6000K	20000LM			
OD-FL200WR2/2			3000K	18000LM			



# LED Flood Light



>> Die-casting Aluminum Heatsink

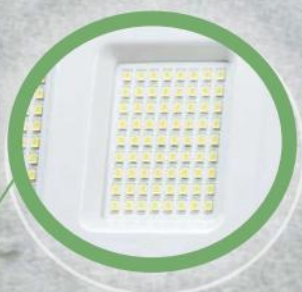

>> 100LM/W LED



>> Waterproof Foam



>> 4mm-thick Iron Stand (400W)

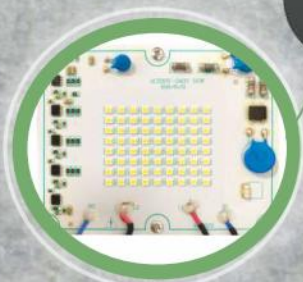

>> Driver on Board

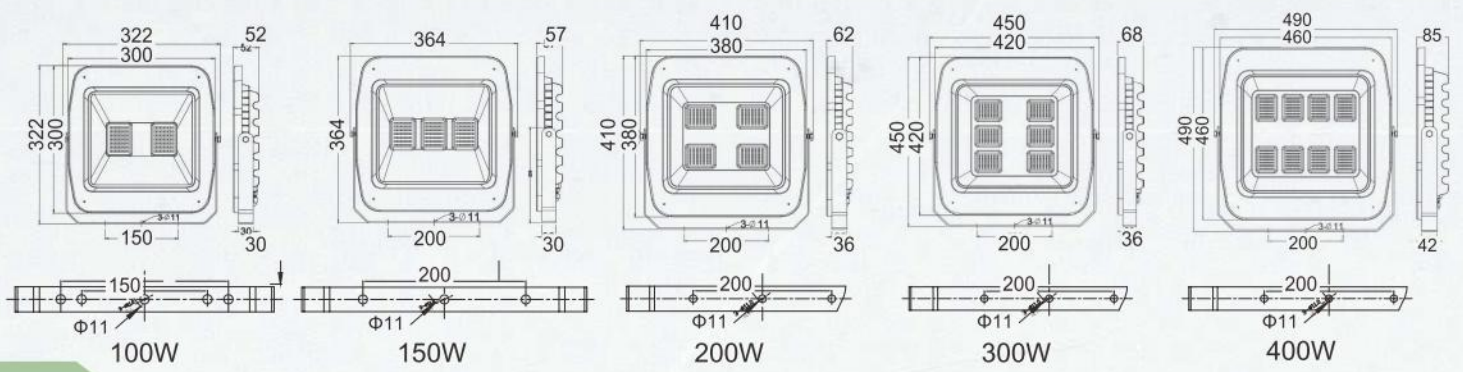

# 220V LED Flood Light

IP66



100W



150W



200W



300W

Item Code	Power	Voltage	CCT	Lumen	CRI	Field Angle	Material
OD-FLDB100D/2	100W	200-240V	5700K	10000LM	≥ 70	150°	Die-casting Aluminum 、 Tempered Glass
OD-FLDB150D/2	150W			15000LM			
OD-FLDB200D/2	200W			20000LM			
OD-FLDB300D/2	300W			30000LM			
OD-FLDB400D/2	400W			40000LM			



# Microwave Sensor Light

IP66



12W



24W



50W



YouTube Clip

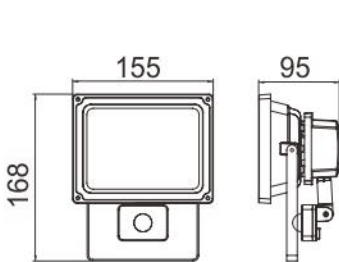

12W

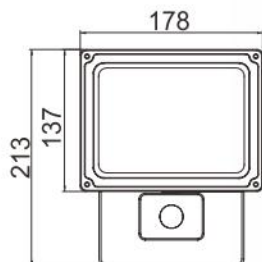

24W

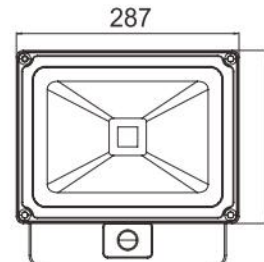
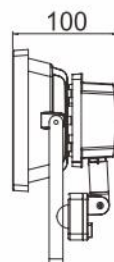

50W

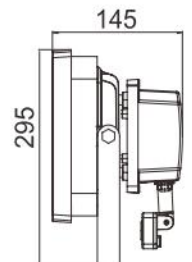

Item Code	Power	Voltage	Driver	CCT	Lumen	CRI	Field Angle	Material
OD-SEFL12DR1 OD-SEFL12WR1	12W	100V-240V	Water-proof Type	6000K 3000K	710LM 680LM	≥ 70	120°	Die-casting Aluminum , Glass
OD-SEFL24DR1 OD-SEFL24WR1	24W			6000K 3000K	1750LM 1540LM			
OD-SEFL50DR1	50W			6000K	3800LM			



# LED Flood Light



50W



Drain Hole ( 100W )



100W

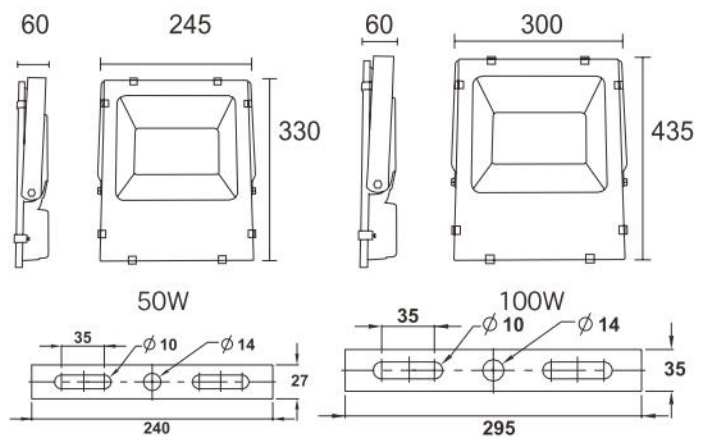

Item Code	Power	Voltage	Driver	CCT	Lumen	CRI	Field Angle	Material
OD-FLS50D	50W	100V-277V	Water-proof Type	6250K	5000LM	≥ 70	140°	Die-casting Aluminum 、 Tempered Glass
OD-FLS50W				3000K	4500LM			
OD-FLS100D	100W			6250K	10000LM			
OD-FLS100W				3000K	9000LM			



OD-10072R1

CD-10071R1

OD-10073



YouTube Clip

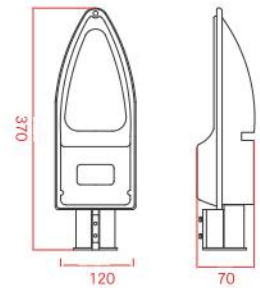
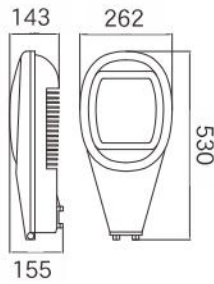
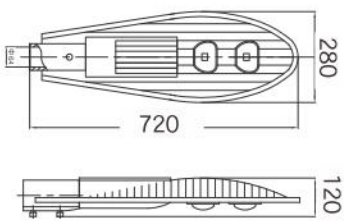

Item Code	Power	Voltage	Driver	CCT	Lumen	CRI	Field Angle	Material
OD-10072R1	100W	100V-240V	Water-proof Type	6500K	12000LM	≥ 70	130°	Die-casting Aluminum PC
OD10071R1	60W			6500K	4560LM		120°	
OD-10071WR1								
OD-10073	22W			6000K	2000LM		130°	

# LED High Bay Light



200W



100W/150W

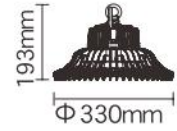

LED-HIBAY100DR3



LED-HIBAY150DR3

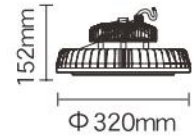

LED-HIBAY200DR6

## Accessories

LED-HIBAY100CN6



Hanging Chain

LED-HIBAY100CN4

Aluminum Cover

LED-HIBAY100CN7

Item Code	Power	Voltage	CCT	Lumen	CRI	Field Angle	Material	Installation	Weight
LED-HIBAY100DR3	100W	100 V   277V	6250K	14000LM	≥ 80	120 °	Die-casting Aluminum 、 PC Cover	Hanging Type	3.5kg
LED-HIBAY100DR5								Ceiling-mounted Type	3.88kg with bracket
LED-HIBAY150DR3	150W			21000LM				Hanging Type	3.84kg
LED-HIBAY150DR5				Ceiling-mounted Type				4.28kg with bracket	
LED-HIBAY200DR6	200W			26000LM		Die-casting Aluminum 、 Tempered Glass	Hanging Type	5.5kg 6kg with bracket	



# LED Linear High Bay Light



YouTube Clip



( 2ft, 200W )



( 4ft, 200W )

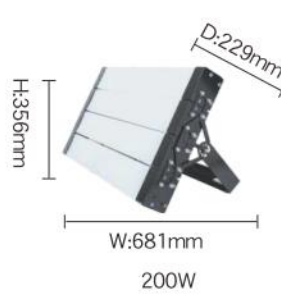
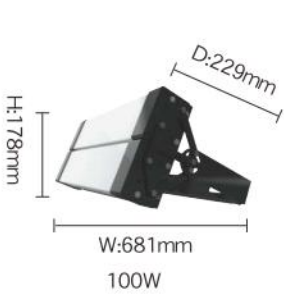

Item Code	Power	Voltage	CCT	Lumen	CRI	Field Angle	Material
LED-HB2L100D	100W	100V-277V	6500K	13000LM	≥ 80	120°	304 Stainless Steel PC Cover
LED-HB2L150D	150W			20000LM			
LED-HB2L200D	200W			26000LM			
LED-HB4L200D	200W			26000LM			

# LED 12V DC Light Strip



INDOOR

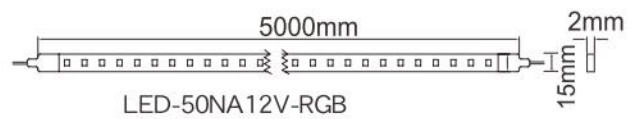

Item Code		Power	Voltage	CCT	Lumen	Field Angle	Material
LED-50NA12V-RGB	5050 LED 60PCS / M	40W	DC12V	Colourful	700LM/ M	120°	Copper plate
LED-50NA12V-W				Warm White			
LED-50NA12V-D				White Light			
LED-50NA12V-B				Blue			
LED-35NA12V-WR2	3528 LED 60PCS / M	20W	DC12V	Warm White	350LM/ M	120°	Copper plate
LED-35NA12V-DR2				White Light			
LED-35NA12V-BR2				Blue			

# LED 12V DC Light Strip

**OUTDOOR**



Item Code		Power	Voltage	CCT	Lumen	Field Angle	Material
LED-50WO12V-WR3	5050 LED 60PCS / M	40W	DC12V	Warm White	700LM/ M	120°	Silicon, Copper plate
LED-50WO12V-DR3				White Light			
LED-35WO12V-WR3	3528 LED 60PCS / M	20W		Warm White	350LM/ M		
LED-35WO12V-DR3				White Light			
LED-35WO12V-BR3				Blue			
LED-35WO12V-RR3				Red			



# LED AC Light Strip 220V

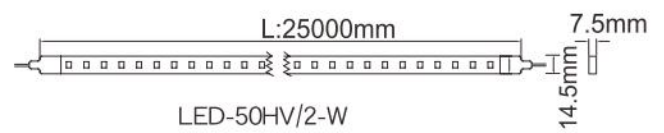
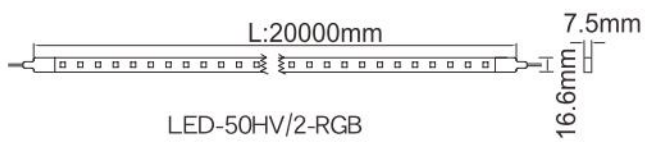

Item Code		Power	Voltage	CCT	Lumen	Field Angle	Material	Length
LED-50HV/2-RGB	5050 LED 60PCS / M	288W	220V	16 - stage Colour changing	600LM/ M	120°	PVC	20 M
LED-50HV/2-W		360W		Warm White				25 M
LED-50HV/2-D				White Light				
LED-50HV/2-B				Blue				

# LED Emergency Light



LED-28001R1



LED-28010



LED-28007

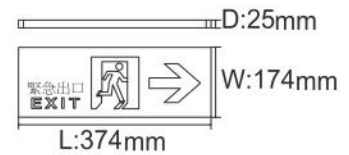
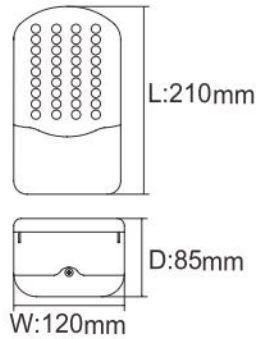
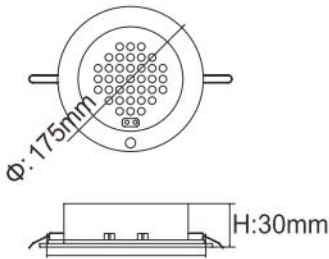

 **Φ150mm**

Item Code	Voltage	Power	Material	Battery	Charging Time	Lighting Time	Lighting Type
LED-28001R1	110V-240V	2.59W	Plastic	NiCd Battery 3.6V 700mAh	48 hrs	1.5 hrs	Light up when power is off
LED-28010		2.52W	Plastic				
LED-28006 (Left) LED-28007 (Right) LED-28008 (Exit) LED-28009 (Two-way)		3.7 W	Iron+Acrylic PMMA	NiCd Battery 3.6V 400mAh			Continuously turn on or Light up when power is off

# LED AC Light Strip 110V

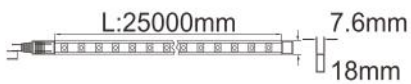
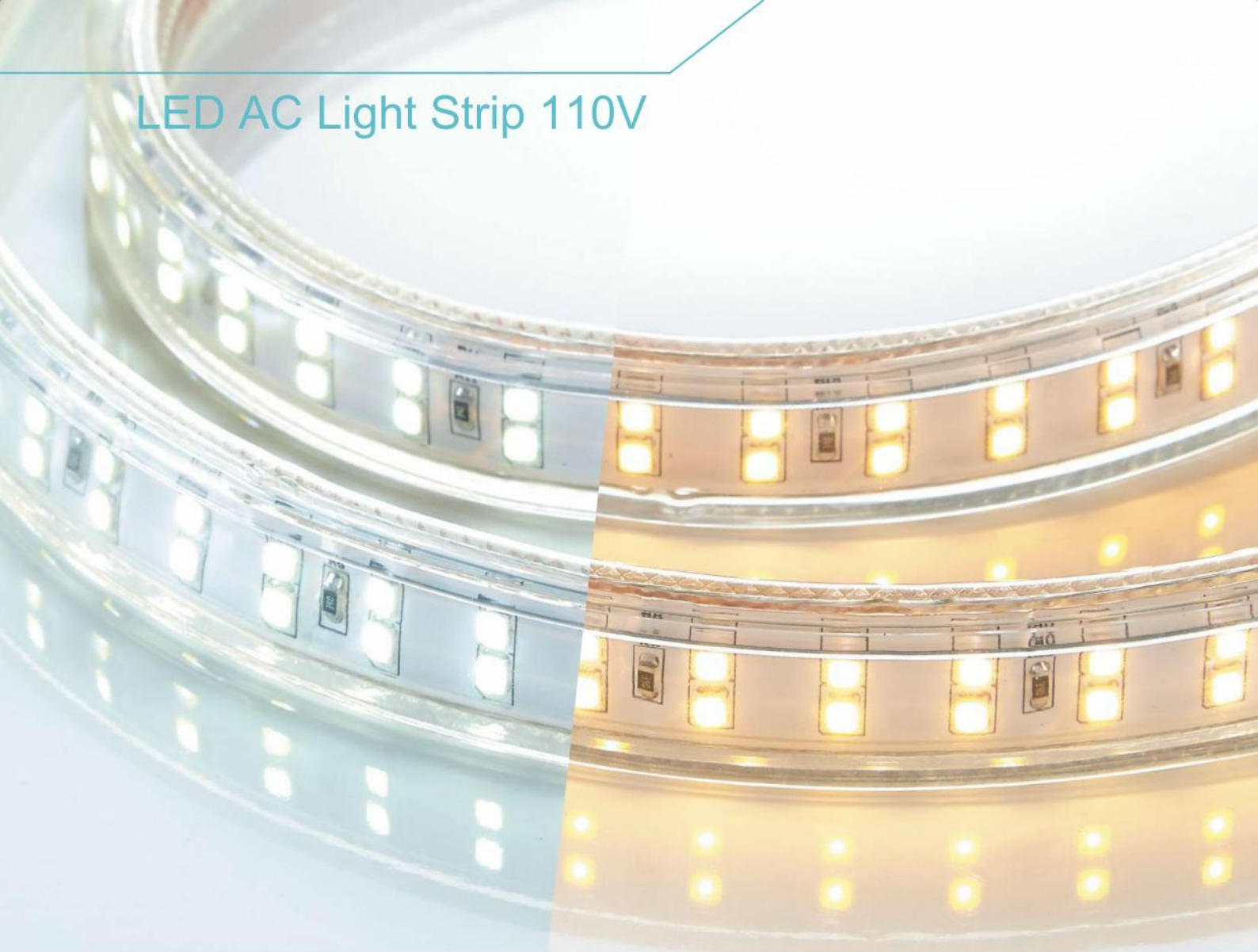

LED-35HV/1-DW



LED-50HV/1-W

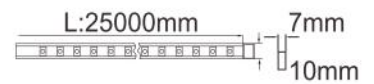

LED-35HV/1-WR2

Item Code		Power	Voltage	CCT	Lumen	Field Angle	Material	Length
LED-35HV/1-DW	3528 LED 60PCS / M	195W	110V	Warm White	900LM/M	120°	PVC	15 M
LED-50HV/1-W	5050 LED 60PCS / M	350W		Warm White	600LM/M			25 M
LED-35HV/1-WR2	3528 LED 60PCS / M	120W		Warm White	300LM/M			
LED-35HV/1-DR2				White Light				
LED-35HV/1-BR2				Blue				



Driver	Item Code	Application	Power	Input	Output	Size
	BF-LED15W-MW	indoor	15W	90-240V	DC12V,0-1.25A	77x40x29mm
	BF-LED20WO-MW	outdoor IP67	20W	90~264V	DC12V,0-1.67A	118x35x32mm
	BF-LED35WO-MW	outdoor IP67	35W	90~264V	DC12V,0-3A	148x40x30mm
	BF-LED60WO-MW	outdoor IP67	60W	90~264V	DC12V,0-5A	162x42x32mm
	BF-LED100WO-MW	outdoor IP67	100W	90~264V	DC12V,0-8.5A	190x52x37 mm
	BF-LED100W-MW	indoor	100W	90~264V	DC12V,0-8.5A	159x97x38 mm



Blue / Brown wires  
AC to Electric Power

Red / Black Wires  
DC to Lamp